

BELLANCA
CITABRIA

**PILOT'S
OPERATING MANUAL**

Bellanca Citabria

PILOT'S OPERATING MANUAL

**MODELS 7ECA (Standard)
7GCAA ("A" Package)
7KCAB ("B" Package)
7GCBC ("C" Package)**
(EFFECTIVE SERIAL NUMBERS -75 AND UP)



BELLANCA

AIRCRAFT CORPORATION

**ALEXANDRIA, MINNESOTA 56308
OSCEOLA, WISCONSIN 54020**

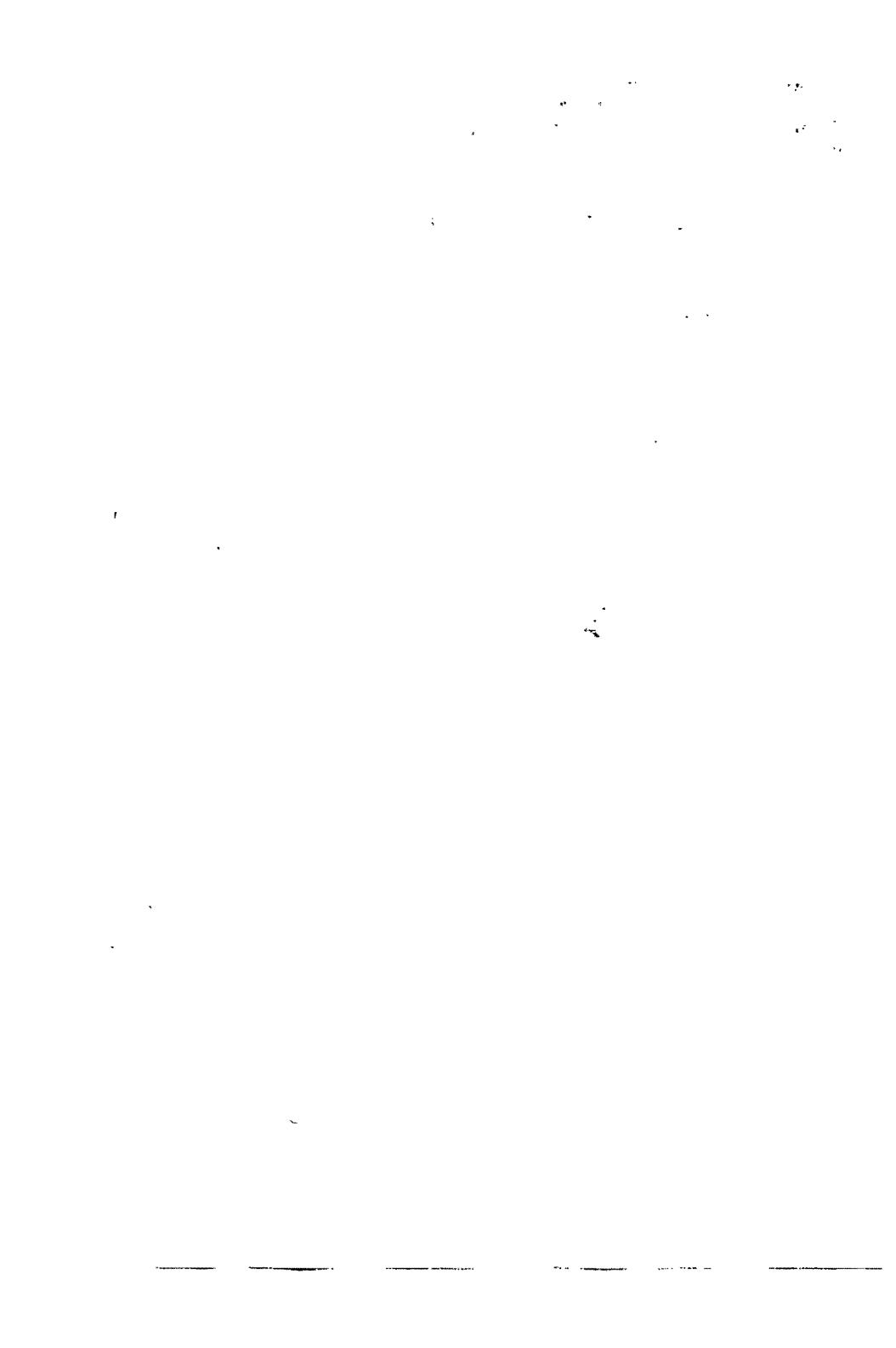

FOREWORD

This manual has been prepared to inform the pilot of the features and systems incorporated in the Bellanca Citabria. Recommended operating procedures and performance data are provided so that maximum utilization can be obtained with the utmost of safety, economy and serviceability.

It is strongly recommended that the pilot be familiar with the aircraft and this manual prior to flight.

This manual applies primarily to the Citabria models indicated on the Title Page. The use of this manual is permissible with older Citabria models, however, systems, descriptions and specific operating limitations may vary slightly (eg. fuel quantity and inverted engine oil system). All placards and operating limitations in a specific aircraft MUST be adhered to.

The words "WARNING", "CAUTION", and "NOTE" are used throughout the manual with the following definitions:

WARNING

An operating procedure, practice or condition, etc. which may result in injury or fatality if not carefully observed or followed.

CAUTION

An operating procedure, practice or condition, etc. which if not strictly observed may damage the aircraft or equipment.

NOTE

An operating procedure, practice or condition, etc. which is essential to emphasize.

TABLE OF CONTENTS

SECTION I	OPERATING LIMITATIONS	1-1
SECTION II	EMERGENCY PROCEDURES	2-1
SECTION III	NORMAL OPERATING PROCEDURES	3-1
SECTION IV	FLIGHT PERFORMANCE.	4-1
SECTION V	WEIGHT AND BALANCE.	5-1
SECTION VI	AIRCRAFT & SYSTEMS DESCRIPTION.	6-1
SECTION VII	SERVICING	7-1

SECTION I

OPERATING LIMITATIONS

INDEX

GENERAL	1-1
FLIGHT OPERATIONS	1-1
POWER PLANT LIMITATIONS	1-2
AIRSPPEED LIMITATIONS.	1-3
WEIGHT AND BALANCE LIMITS	1-3
FLIGHT LOAD FACTORS	1-4
MANEUVERS	1-4
REQUIRED PLACARDS	1-4

GENERAL

This section lists all power plant and airframe operating limitations. These limitations are also indicated in the aircraft in the form of placards and instrument color markings. The aircraft placards and instrument markings are to be the authority if an inconsistency exists with this manual.

Limitations pertaining to optional equipment such as floats or external spray units must be obtained from the respective manufacturer.

WARNING

All operating limitations must be strictly adhered to for reasons of safety and serviceability.

FLIGHT OPERATIONS

All Citabria models are approved in the Normal and Acrobatic Category.

Day or night flight in VFR conditions only is approved providing the aircraft is equipped with the required equipment and is in operating condition as specified under Part 91 of the Federal Air Regulations (F.A.R.'s).

Flight into known icing conditions is prohibited.

POWER PLANT LIMITATIONS

Aircraft Model	7ECA	7GCAA, 7GCBC	7KCAB
Engine, Lycoming	0-235-C1	0-320-A2B or A2D	AE10-320- E2A, -E2B
Rated Horsepower (hp/rpm)	115/2800	150/2700	150/2700
Fuel, Aviation Grade, Min. Octane Approved For Continuous Use	80/87 100/130* *(low lead)	80/87 100/130	80/87 100/130
Tachometer			
Normal Range (green arc) (rpm)	1800-2800	1800-2700	1800-2700
Maximum (red line) (rpm)	2800	2700	2700
Cylinder Head Temperature			
Normal Range (green arc) (°F)	90-500	90-500	90-500
Maximum (red line) (°F)	500	500	500
Oil Temperatures			
Normal Range (green arc) (°F)	100-245	100-245	100-245
Maximum (red line) (°F)	245	245	245
Oil Pressure			
Normal Range (green arc) (psi)	60-100	60-100	60-100
Caution Range (yellow arc) (psi)	25-60	25-60	25-60
Maximum (red line) (psi)	100	100	100
Minimum (red line) (psi)	25	25	25
Fuel Pressure			
Normal Range (green arc) (psi)	N/A	N/A	12-45
Maximum (red line) (psi)	N/A	N/A	45
Minimum (red line) (psi)	N/A	N/A	12

AIRSPEED LIMITATIONS

AIRSPEED DESIGNINATION

	CAS (MPH)
Never Exceed (V_{NE} - red line)	162
Caution Range (yellow arc).	120-162
Maximum Structural Cruise (V_{NO})	120
Normal Operating Range (green arc)	50-120
Flap Operating Range (V_{FE} - white arc)	45-90 (7GCBC)
Maneuvering (V_A - @ 1650 lbs).	120

NOTE

- CAS - Calibrated airspeed is indicated airspeed (IAS) corrected for installation and instrument error.
- IAS - Indicated airspeed assumes zero instrument error only.
- V_{NE} - Maximum safe airspeed, not to be exceeded at any time.
- V_{NO} - Not to be exceeded except in smooth air only and then with caution.
- V_{FE} - Not to be exceeded with flaps extended.
- V_A - No full or abrupt control movements allowed above this airspeed.

WEIGHT AND BALANCE LIMITS

Aircraft Model and Weight Center of Gravity Range

		Normal Category	Acrobatic Category
7ECA	1650 lbs maximum	14.2"-19.2"	14.2"-17.3"
	1325 lbs or less	10.5"-19.2"	10.5"-17.3"
7GCAA, KCAB	1650 lbs maximum	10.5"-18.2"	10.5"-16.0"
	1325 lbs or less	10.5"-18.2"	10.5"-16.0"
7GCBC	1650 lbs maximum	14.2"-19.2"	14.2"-16.3"
	1325 lbs or less	10.5"-19.2"	10.5"-16.3"

NOTE

All measurements are aft of the datum line which is the wing leading edge. Center of gravity limits between 1325 lbs. and 1650 lbs. is a straight line variation between these points. See Section V for the flight envelope and loading instructions.

FLIGHT LOAD FACTORS (1650 Lbs. Normal and Acrobatic Category)

Positive Load +5.0 G's Maximum
Negative Load -2.0 G's Maximum

MANEUVERS

The following aerobatic maneuvers and entrance speeds are approved with no baggage and the aft center of gravity (C.G.) within the limits specified for the Acrobatic Category.

Chandelle, Lazy Eights120 MPH CAS
Barrel or Slow Roll.120 MPH CAS
Immelman145 MPH CAS
Loop or Clover Leaf.140 MPH CAS
Split S.80 MPH CAS
Snap Roll.85 MPH CAS
Vertical Reverse85 MPH CAS
Cuban Eight.145 MPH CAS
Spins.Slow Deceleration
Inverted Flight (7KCAB Only)Limited to 2 Minutes

REQUIRED PLACARDS

In Full View Of Pilot

Operations Limitation Card
(Includes all limitations listed in this Section in addition to weight and balance information)

In Baggage Compartment

"Maximum Baggage - 100 Lbs."

On Forward Left Side Window

"Do Not Open Above 130 MPH"

Above Fuel Shutoff Rod

"Fuel 35 Gal. Usable - Down On"

On Emergency Door Release Handle

"Emergency Door Release - Pull Pin, Pull Handle"

PLACARDS (Continued)

Top Half Cabin Door - Forward (Split-type door only)

"Do Not Exceed 90 MPH With Door Open"

Right Window Sill (When folding rear seat is installed)

**"Seat Back Restrainer Cable Must Be Connected Before Flight
Unless Control Stick Is Removed"**

Adjacent To Strobe Light Switch

**"Turn Off Strobe Lights When Taxing In Vicinity Of Other
Aircraft Or During Flight Through Clouds, Fog, or Haze.
Standard Position Lights To Be On For All Night Operations."**

On Radio Panel (If radio installed)

"Compass Calibrated With Radio On"

On Fuel Caps

"Fuel 80/87 Octane 18 Gals."

On Instrument Panel

"Occupy Front Seat When Flying Solo"

**Acrobatic Maneuvers Limitation Card (See "Maneuvers"
this Section)**

On Battery Access Panel

**"Service Battery Every 50 Hrs. Of Normal Flight. Service
Every 10 Hrs. Of Acrobatic Flight."**

SECTION II

EMERGENCY PROCEDURES

INDEX

GENERAL	2-1
FIRE	2-2
ENGINE FIRE DURING START	2-2
ENGINE FIRE IN FLIGHT	2-2
ELECTRICAL FIRE	2-3
ALTERNATOR/ELECTRICAL FAILURE	2-3
ENGINE MALFUNCTION	2-4
ENGINE FAILURE ON TAKE-OFF	2-4
ENGINE AIR RESTART	2-4
PARTIAL POWER LOSS/ROUGH RUNNING	2-5
ABNORMAL OIL PRESSURE/TEMPERATURE INDICATIONS	2-5
LANDING EMERGENCIES	2-5
PRECAUTIONARY LANDING APPROACH	2-5
FORCED LANDING (COMPLETE POWER FAILURE)	2-6
DITCHING	2-6
UNUSUAL FLIGHT CONDITIONS	2-7
SEVERE TURBULENCE	2-7
STALLS	2-7
SPINS	2-7
INFLIGHT OVERSTRESS	2-8
EMERGENCY EXIT/BAIL OUT	2-8

GENERAL

This section covers the recommended procedures to follow during emergency and adverse flight conditions. As it is not possible to define every type of emergency that may occur, it is the pilot's responsibility to use sound judgement based on personal experience and knowledge of the aircraft to determine the best course of action.

It is considered mandatory that the pilot be familiar with this entire manual, in particular, the "Emergency Procedures" section prior to flight.

NOTE

All airspeeds in this section are indicated airspeeds (IAS) unless stated otherwise.

FIRE

ENGINE FIRE DURING START

If the fire is believed to be confined to the intake or exhaust system (result of flooding engine):

- 1) Continue cranking engine with starter
- 2) Mixture Control - IDLE CUT-OFF
- 3) Throttle - FULL OPEN
- 4) Inspect aircraft thoroughly for damage and cause prior to restart

If fire persists or is not limited to intake or exhaust system:

- 1) Mixture Control - IDLE CUT-OFF
- 2) Fuel Shut-Off Valve - OFF
- 3) Electrical and Magneto Switches - ALL OFF
- 4) Exit Aircraft
- 5) Direct fire extinguisher through the bottom of the nose cowl or through the cowl inspection door

ENGINE FIRE IN FLIGHT

- 1) Mixture Control - IDLE CUT-OFF
- 2) Fuel Shut-Off Valve - OFF
- 3) Electrical and Magneto Switches - ALL OFF
- 4) Cabin Heat - OFF front and rear
- 5) Use hand fire extinguisher if available
- 6) Land immediately using "Forced Landing Procedures"

WARNING

Do not attempt to restart engine.

ELECTRICAL FIRE

An electrical fire is usually indicated by an odor of hot or burning insulation.

- 1) Electrical Switches - ALL OFF (leave magneto switches ON)
- 2) Air Vents/Windows - OPEN if necessary for smoke removal and ventilation
- 3) Use hand fire extinguisher if available
- 4) If fire continues, land immediately

If fire/smoke stops and electrical power is required for the remainder of the flight, turn the master switch ON followed by the desired circuit switch. Allow sufficient time between turning on each switch in order that the faulty circuit may be located and switched OFF.

ALTERNATOR/ELECTRICAL FAILURE

An alternator failure is indicated by a steady discharge on the ammeter.

- 1) Master Switch - CYCLE in attempt to reset the overvoltage relay.
- 2) If excessive battery discharge continues, turn OFF all nonessential electrical equipment to conserve battery power.
- 3) Land as soon as practical as the battery will furnish electrical power for a limited time only.

If only one circuit (e.g. Radio) appears to be inoperative, remove and replace the suspected fuse with a spare of the same amperage rating. The spare fuses are located above the regular fuses in use.

NOTE

Engine operation is unaffected by a complete electrical system failure with the exception of the engine starter.

ENGINE MALFUNCTION

ENGINE FAILURE ON TAKE-OFF

If sufficient runway remains:

- 1) Throttle - CLOSED
- 2) Land using maximum braking after touchdown.

If airborne and insufficient runway remains for landing, attempt an engine restart if sufficient altitude permits:

- 1) Fuel Shut-Off Valve - CHECK ON
- 2) Mixture Control - FULL RICH
- 3) Carburetor/Alternate Air - FULL HOT
- 4) Magneto Switches - BOTH ON (Up)
- 5) Fuel Boost Pump - ON (7KCAB Only)

If no restart is possible:

- 1) Select most favorable landing area ahead
- 2) Flaps - FULL DOWN (7GCBC)

WARNING

Maintain flying speed at all times and do not attempt to turn back toward the runway unless sufficient altitude has been achieved.

ENGINE AIR RESTART

- 1) Maintain Airspeed - 65 MPH minimum recommended
- 2) Magneto Switches - BOTH ON (Up)
- 3) Fuel Boost Pump - ON (7KCAB ONLY)
- 4) Mixture - FULL RICH or as required at high altitude
- 5) Fuel Shut-Off Valve - CHECK ON
- 6) Carburetor/Alternate Air - FULL HOT
- 7) Engine Primer - CHECK OFF
- 8) If restart not possible, change throttle, mixture, primer, magneto, carburetor/alternate air heat settings, in attempt to restart
- 9) Follow "Forced Landing Procedure" if unable to restart

NOTE

The engine starter may be engaged in flight should the engine stop windmilling.

PARTIAL POWER LOSS/ROUGH RUNNING

- 1) Follow the engine air restart procedures
- 2) Land as soon as practical using "Precautionary Landing Approach" procedures

Carburetor icing is indicated if a gradual RPM loss is noticed. The carburetor/alternate air should be FULL HOT as long as suspected icing conditions exist.

ABNORMAL OIL PRESSURE/TEMPERATURE INDICATIONS

Oil pressure and temperature problems are usually related with one affecting the other. Before any drastic action is taken, cross check other engine instruments and control settings in an attempt to determine the source of the problem.

High oil temperature is generally a result of loss of oil, overheating (note CHT if available) or a malfunctioning oil cooler by-pass valve. If the situation remains unchecked, oil pressure usually drops resulting in possible engine damage. Power should be reduced while maintaining cruise airspeed; place mixture in FULL RICH position and land as soon as practical.

Little or no oil pressure is usually caused by a failed pressure relief valve, pump, loss of oil, clogged oil line, high oil temperature or a defective gauge. A landing should be made as soon as practical using minimum RPM changes. Plan a "Precautionary Landing Approach" as complete engine failure is possible at any time.

LANDING EMERGENCIES

PRECAUTIONARY LANDING APPROACH

A precautionary landing approach should be used whenever power is still available but a complete power failure is considered imminent. Maintain a higher and closer pattern than normal in attempt to remain in gliding distance of the intended touchdown point. Use the normal landing procedures in addition:

- 1) Airspeed - 65 MPH recommended (60 MPH minimum)
- 2) Throttle - CLOSED when in gliding distance of runway
- 3) Flaps - LOWER AS NEEDED in increase approach descent angle (7GBCB)

NOTE

Slipping the aircraft by cross controlling the rudder and ailerons will increase the rate of descent both with or without flaps. If a cross-wind exists, place the lower wing into the wind.

FORCED LANDING (Complete Power Failure)

If the engine cannot be restarted in flight, trim the aircraft to the recommended glide speed. Remain within gliding distance of the intended point of landing. Maintain a higher and closer pattern than normal making allowance for wind.

Additional altitude can be lost by extending flaps or slipping the aircraft. Diving the aircraft in an attempt to lose altitude when flying into a headwind will only increase the required landing distance.

- 1) Airspeed - Maintain 60-65 MPH
- 2) Mixture - IDLE CUT-OFF
- 3) Fuel Shut-Off Valve - OFF
- 4) Master Switch - ON
- 5) Flaps - UP to increase glide range (7GCBC)
- 6) Radio - MAYDAY 121.5 MHz
- 7) Attempt to position the aircraft approximately 1000 feet above ground level (AGL) over the intended point of landing or 500 feet when downwind and abeam the intended point of landing.
- 8) Electrical Switches - ALL OFF
- 9) On Final Approach
 - a) Airspeed - 65 MPH (60 MPH minimum)
 - b) Flaps - DOWN after intended point of landing assured (7GCBC)
- 10) Touchdown with minimum airspeed (three point full stall) if landing on rough terrain.

NOTE

If necessary, after aircraft has come to a complete stop, remove and activate the emergency locator transmitter from the aircraft for increased transmitting range.

DITCHING

Should it become necessary to make a forced landing over water, follow the "Forced Landing Procedures" in addition to the following:

- 1) Cabin Side Door - JETTISON
- 2) Land into wind if high winds are evident or parallel to swells with calm winds
- 3) Flaps - UP (allows higher nose attitude at touchdown)
- 4) Contact the water with nose high attitude
- 5) DO NOT STALL prior to touchdown
- 6) After coming to complete stop - EXIT AIRCRAFT

NOTE

Aircraft cannot be depended on to provide flotation after contacting the water.

UNUSUAL FLIGHT CONDITIONS

SEVERE TURBULENCE

To prevent overstressing the aircraft do not exceed 120 MPH in rough air. To minimize personal discomfort, decrease the IAS below 80 MPH. Maintain a level flight attitude rather than flying by reference to the altimeter and airspeed indicator as the pitot-static instruments may become very erratic.

STALLS

The Citabria stall characteristics are conventional. The stall warning horn, if installed, will proceed the actual stall by 5-10 MPH depending on the amount of power used. There is sufficient aerodynamic buffeting preceding the stall to provide the pilot with an adequate warning.

Aileron control response in a fully stalled condition is marginal. Large aileron deflections will aggravate a near stalled condition and their use is not recommended to maintain lateral control. The rudder is very effective and should be used for maintaining lateral control in a stalled condition with the ailerons placed in a neutral position.

To recover from a stall, proceed as follows:

- 1) Nose Attitude - LOWER with forward movement of control stick
- 2) Throttle - FULL OPEN simultaneously with control stick movement
- 3) Use rudder to maintain lateral control

SPINS

If a spin is inadvertently entered, immediate recovery should be initiated. The recovery procedure is as follows:

- 1) Throttle - CLOSED
- 2) Rudder - FULL DEFLECTION opposite direction of rotation
- 3) Elevator - SLIGHTLY FORWARD OF NEUTRAL
- 4) Ailerons - NEUTRAL POSITION

When rotation stops (1/2 - 1 turn after recovery initiated)

- 5) Rudder - NEUTRALIZE
- 6) Nose Attitude - RAISE smoothly to level flight attitude

WARNING

During the spin recovery, the airspeed will build very rapidly with a nose low attitude; Do not use full or abrupt elevator control movements.

INFLIGHT OVERSTRESS

Should an overstress occur due to exceeding the airspeed or load factor limits, aerobatics should be terminated immediately. Fly at a reduced airspeed, (60 - 70 MPH) to a suitable landing point. DO NOT under any circumstances, make large control movements or subject the aircraft to additional G loadings above that required for straight and level flight. After landing, the aircraft should be inspected by a mechanic prior to the next flight.

EMERGENCY EXIT/BAIL OUT

- 1) Throttle - CLOSED
- 2) Door - JETTISON using Emergency Jettison Handle
- 3) Use the cabin door frame for support. Dive straight out and slightly aft of wing struts.
- 4) Parachute - OPEN immediately when clear of aircraft

NOTE

Emergency ground exit is also possible through the left window.

SECTION III

NORMAL OPERATING PROCEDURES

INDEX

GENERAL	3-1
PREFLIGHT INSPECTION.	3-2
BEFORE STARTING	3-3
STARTING.	3-4
STARTING (7KCAB ONLY)	3-4
TAXI.	3-5
BEFORE TAKE-OFF	3-6
TAKE-OFF (Normal)	3-6
TAKE-OFF (Obstacle)	3-7
TAKE-OFF (Soft Field)	3-7
CLIMB	3-7
CRUISE.	3-8
AEROBATICS.	3-8
DESCENT	3-9
LANDING (Normal).	3-9
LANDING (Obstacle).	3-10
SHUTDOWN.	3-10

GENERAL

This section covers all recommended normal operating procedures using a checklist format whenever possible with additional information if further explanation is required.

NOTE

All recommended airspeeds in this section are INDICATED AIRSPEEDS (IAS) with the aircraft loaded to the maximum gross weight of 1650 lbs.

PREFLIGHT INSPECTION

1) Cabin

- a) Cabin Door - CHECK condition, security
- b) Flight Controls - CHECK freedom of movement
- c) Magneto and Electrical Switches - OFF (check operation of lights if required and stall warning system with respective switches ON)
- d) Fuel Quantity Gauges - CHECK quantity
- e) Fuel Shut-Off Valve - ON
- f) Seat Belts - CHECK CONDITION - SECURE rear belt and harness if not in use
- g) Emergency Locator Transmitter - ARMED

2) Right Wing

- a) Wing Root Fairing - CHECK secure
- b) Flaps - CHECK condition, freedom of movement, security (76CBC)
- c) Aileron - CHECK condition, freedom of movement, security
- d) Wing Tip and Light - CHECK condition
- e) Wing and Struts - CHECK condition, security
- f) Tie-Down - REMOVE
- g) Pitot-Static Tube - CHECK unobstructed (visual check on l
- h) Fuel - CHECK quantity, color, cap secure

3) Right Main Gear

- a) Chocks - REMOVE
- b) Tires - CHECK condition, inflation
- c) Brakes - CHECK condition, leakage

4) Nose Section

- a) Windshield - CHECK condition, cleanliness
- b) Oil - CHECK quantity, dip stick secure
- c) Fuel - DRAIN gascolator, CHECK leakage
- d) Engine Compartment - CHECK condition, leakage, etc.
- e) Cowling and Inspection Door - CHECK condition, security
- f) Propeller and Spinner - CHECK condition, security
- g) Air Filter - CHECK condition
- h) Landing Light - CHECK condition

5) Left Main Gear

- a) Same as right main gear

PREFLIGHT INSPECTION (Continued)

6) Left Wing

- a) Same as right wing, in addition
- b) Fuel Vent - CHECK unobstructed
- c) Stall Warning Vane - CHECK freedom of movement (if installed)

7) Fuselage (Left Side)

- a) Fabric - CHECK condition, oil, battery acid leakage, etc.
- b) Windows - CHECK condition, cleanliness
- c) Fuel Belly Drain - DRAIN, CHECK leakage
- d) Radio Antenna(s) - CHECK secure

8) Empennage

- a) Horizontal Stabilizer and Brace Wires - CHECK condition, security
- b) Vertical Stabilizer and Tail Light - CHECK condition
- c) Elevator, Trim Tab and Rudder - CHECK condition, freedom of movement, security
- d) Tail Wheel - CHECK condition, inflation, security
- e) Tie-Down - REMOVE

9) Fuselage (Right Side)

- a) Same as fuselage left side (no fuel drain on right side)

BEFORE STARTING

- 1) Seat Belts/Shoulder Harness - FASTENED
- 2) Fuel Shut-Off Valve - ON
- 3) Brakes - SET
- 4) Electrical Switches - OFF
- 5) Cabin Door - CLOSED (windows as desired)

STARTING (Except 7KCAB)

- 1) Master Switch - ON
- 2) Magneto Switches - ON (2)
- 3) Throttle - CRACKED OPEN (1/2" - 1")
- 4) Carburetor Air - COLD
- 5) Mixture - FULL RICH
- 6) Prime - AS REQUIRED, CHECK locked
- 7) Propeller - CLEAR, front and rear
- 8) Starter Button - PUSH, release after engine starts
- 9) Throttle - 1000 RPM
- 10) Oil Pressure - CHECK, must indicate pressure within 30 seconds maximum
- 11) Radio/Light Switches - AS DESIRED

STARTING (7KCAB ONLY)

- 1) Master Switch - ON
- 2) Magneto Switches - ON (2)
- 3) Throttle - CRACKED OPEN (1/2" - 1")
- 4) Alternate Air - COLD
- 5) Mixture - FULL RICH
- 6) Fuel Boost Pump - ON until fuel pressure is indicated then OFF (priming)
- 7) Mixture - IDLE CUT-OFF
- 8) Propeller - CLEAR, front and rear
- 9) Starter - ENGAGE, release after engine fires
- 10) Mixture - FULL RICH after engine fires
- 11) Throttle - 1000-1200 RPM
- 12) Oil Pressure - CHECK, must indicate pressure within 30 seconds maximum
- 13) Radio/Light Switches - AS DESIRED

The use of the fuel primer will vary with each engine and temperature condition. If the engine is warm, little or no prime is required. During cold weather conditions, 4 - 6 priming strokes may be required. With the 7KCAB, increase the priming time with the mixture control and fuel boost pump.

CAUTION

Do not overprime or excessively pump the throttle (carburetor accelerator pump) due to the resulting fire hazard.

STARTING (Continued)

To clear an engine that has been flooded due to excessive priming, proceed as follows:

- 1) Fuel Boost Pump - OFF (7KCAB only)
- 2) Mixture - IDLE CUT-OFF
- 3) Throttle - FULL OPEN
- 4) Magneto Switches - OFF
- 5) Starter - ENGAGE for several propeller revolutions
- 6) Repeat normal starting procedures using no prime

CAUTION

Limit the use of the starter to 30 seconds duration maximum with a two minute cooling off period between each starter engagement.

During cold weather operation, (below 20°F) it is recommended that the engine be pre-heated by directing warm air through the opening in the bottom or front of the engine cowl. This practice will prolong the service life of the engine and starter.

During ground operation, the mixture should be FULL RICH and the carburetor/alternate air COLD to insure good engine cooling and filtered air. Prolonged idle below 1000 RPM is not recommended due to plug fouling and insufficient cooling air when the aircraft is not in motion.

TAXI

Taxi operations during high winds requires the conventional use of the flight controls. With a head wind or quartering head wind, place the control stick full aft and into the wind. With a tail wind or quartering tail wind, use the opposite procedures. The use of the wheel brakes in conjunction with the rudder will assist the pilot in maintaining directional control.

STARTING (Continued)

To clear an engine that has been flooded due to excessive priming, proceed as follows:

- 1) Fuel Boost Pump - OFF (7KCAB only)
- 2) Mixture - IDLE CUT-OFF
- 3) Throttle - FULL OPEN
- 4) Magneto Switches - OFF
- 5) Starter - ENGAGE for several propeller revolutions
- 6) Repeat normal starting procedures using no prime

CAUTION

Limit the use of the starter to 30 seconds duration maximum with a two minute cooling off period between each starter engagement.

During cold weather operation, (below 20°F) it is recommended that the engine be pre-heated by directing warm air through the opening in the bottom or front of the engine cowl. This practice will prolong the service life of the engine and starter.

During ground operation, the mixture should be FULL RICH and the carburetor/alternate air COLD to insure good engine cooling and filtered air. Prolonged idle below 1000 RPM is not recommended due to plug fouling and insufficient cooling air when the aircraft is not in motion.

TAXI

Taxi operations during high winds requires the conventional use of the flight controls. With a head wind or quartering head wind, place the control stick full aft and into the wind. With a tail wind or quartering tail wind, use the opposite procedures. The use of the wheel brakes in conjunction with the rudder will assist the pilot in maintaining directional control.

BEFORE TAKE-OFF

- 1) Brakes - SET
- 2) Flight Controls - CHECK freedom of movement, proper operation
- 3) Elevator Trim - SET take-off position
- 4) Flight Instruments/Radio(s) - CHECK and SET
- 5) Flaps - SET as desired (7GCBC only)
- 6) Fuel Shut-Off Valve - ON
- 7) Mixture - FULL RICH (lean as required for high altitude)
- 8) Engine Instruments - CHECK normal indications
- 9) Engine Run-Up - 1800 RPM (Elevator Control - FULL BACK)
 - a) Magnetos - CHECK (200 RPM maximum drop, 50 RPM maximum differential)
 - b) Carburetor/Alternate Air - CHECK operation then return to COLD position
 - c) Engine Instruments - CHECK normal indications
 - d) Throttle - 1000 RPM
- 10) Fuel Boost Pump - ON (7KCAB only)
- 11) Cabin Door and Windows - CLOSED and LATCHED
- 12) Seat Belts/Shoulder Harness - FASTENED

High power operation (above 2200 RPM) and engine run-up should be made into the wind and kept to a minimum especially during high temperature conditions. The stick should also be held full aft to prevent the possibility of the aircraft nosing over.

TAKE-OFF (Normal)

- 1) Flaps - UP (7GCBC)
- 2) Throttle - FULL OPEN applying smoothly
- 3) Engine Instruments - CHECK normal indications
- 4) Attitude - RAISE TAIL to level flight attitude
- 5) Lift-Off - 55-60 MPH
- 6) Climb - 75-80 MPH

Take-off characteristics are conventional. It is recommended to raise the tail with the elevator as soon as possible for better forward visibility and directional control.

CAUTION

In the level flight attitude, the wheel brakes are very sensitive. It is recommended that directional control be maintained with the use of the rudder only.

TAKE-OFF (Normal) (Continued)

During crosswind conditions, place the control stick into the wind (up wind aileron UP) and assume a tail high attitude with the elevator to prevent drifting or premature lift-off.

High altitude take-offs are accomplished by using the normal take-off procedures with the addition of leaning the mixture control for smooth engine operation.

TAKE-OFF (Obstacle)

During an obstacle take-off, use the normal take-off procedures with the following exceptions:

- 1) Flaps - SET 14° (2nd notch, 7GCBC only)
- 2) Lift-Off - 50-55 MPH
- 3) Climb - 58 MPH (best angle of climb) until clear of obstacle

TAKE-OFF (Soft Field)

For soft field take-off, use the normal take-off procedures with the following exceptions:

- 1) Flaps - SET 14° (2nd notch 7GCBC only)
- 2) Attitude - TAIL LOW but clear of ground
- 3) Lift-Off - ASSIST using elevator
- 4) After Lift-Off - LEVEL FLIGHT to obtain safe margin of airspeed prior to climb
- 5) Flaps - UP (7GCBC only)

WARNING

The aircraft will lift-off at very low IAS but continued climb-out below 58 MPH immediately after take-off is not recommended.

CLIMB

- 1) Throttle - FULL OPEN
- 2) Mixture - FULL RICH below 5000 feet
- 3) Airspeed - 75-80 MPH

For maximum performance climbs, use full throttle and the following conditions:

BEST RATE OF CLIMB

- 1) Flaps - UP
- 2) Airspeed - 69 MPH

BEST ANGLE OF CLIMB

- 1) Flaps - 14° (2nd notch 7GCBC only)
- 2) Airspeed - 58 MPH

CRUISE

- 1) Level-Off - TRIM
- 2) Airspeed - ACCELERATE to desired cruise airspeed
- 3) Throttle - SET RPM to cruise power
- 4) Fuel Boost Pump - OFF (7KAB Only)
- 5) Mixture - LEAN when below 75% power

The fuel mixture should be leaned at any altitude when below 75% of maximum power. Lean to peak EGT if equipped. If no EGT is installed, lean until engine roughness is noted then enrich until smooth.

WARNING

Range and endurance information is based on a properly leaned fuel mixture. Failure to lean the fuel mixture will increase fuel consumption appreciably.

AEROBATICS

The Citabria is certified in the Acrobatic Category. However, this desirable capability also places a much greater demand on the pilot's ability, knowledge of the aircraft and current regulations. The following information is provided to make aerobatic flying enjoyable, with the utmost emphasis on safety.

Federal Aviation Regulations (FARs) Part 91.71 specify the airspace and altitudes required for aerobatic flight. The minimum altitude of 1500 FT AGL is the pilot's greatest safety factor and should not be compromised. The wearing of approved parachutes is specified in Part 91.15. It is strongly recommended that parachutes always be worn during aerobatic flight.

The Citabria structure is designed to withstand a maximum load factor of +5 G's and -2 G's at a maximum gross weight of 1650 lbs. (includes approximately 500 lbs. useful load) and below. A change in the gross weight also changes the effective load factor limit. To fly at reduced weights increases the safety factor and improves performance. To fly above 1650 lbs. is not only prohibitive, but also greatly increases the chances of a serious overstress resulting in damage or possible structural failure.

The Citabria exhibits excellent control response and stability. However, to maintain this for aerobatic flight, the rear center of gravity (C.G. limit is critical. The rear C.G. is therefore reduced when flying in the Acrobatic Category. This limit is specified in Section I. The flight envelope in Section V also reflects this change. For this reason baggage is NOT allowed during aerobatic flight. Also, all personal equipment (charts, flight computer, etc.) should be properly secured.

AEROBATICS (Continued)

A person learning to fly must be taught how to do so safely. The same holds true for a pilot learning aerobatics. To attempt an aerobatic maneuver with no prior instruction is extremely dangerous and NOT recommended.

Aerobatic flight places a greater demand on both the pilot and aircraft. A thorough pre-flight inspection/evaluation for both is considered essential. The pilot must know and abide by the limitations of the aircraft and his own personal limitations as well. At the completion of the flight, a post-flight inspection of the aircraft should also be conducted. If any discrepancies or doubts exist that concern airworthiness, consult a mechanic prior to the next flight.

DESCENT

- 1) Mixture - FULL RICH
- 2) Throttle - REDUCE as desired
- 3) Airspeed - AS DESIRED

The descent should be made with enough power to maintain cylinder head and oil temperatures in green arc. If possible, avoid windmilling the engine with the propeller by reducing airspeed or increasing power.

LANDING (Normal)

- 1) Seat and Shoulder Harness - FASTENED
- 2) Mixture - RICH
- 3) Fuel Boost Pump - ON (7KCAB)
- 4) Brakes - CHECK FIRM (Park Brake - OFF)
- 5) Flaps - AS DESIRED (7GCBC)
- 6) Approach Airspeed - 60-70 MPH
- 7) Throttle - AS DESIRED to control rate of descent
- 8) After Touchdown - FLAPS UP (7GCBC) - Brake as required

Aircraft landing characteristics are conventional. Either wheel landings or full stalls (3 point) are permissible. During gusty wind conditions, increase airspeed approximately 5 MPH above normal followed by a wheel landing.

Full stall (3 point) landings are recommended for soft or rough fields.

LANDING (Normal) (Continued)

Crosswind approaches can best be accomplished by using the wing down top rudder method followed by a wheel landing. Keep the lower wing into the wind after touchdown. Do not drop the tail until airspeed is well below flying speed.

CAUTION

The use of wheel brakes is not recommended until after the tail wheel is in contact with the ground. For maximum braking, the control stick should be FULL AFT.

LANDING (Obstacle)

Use of normal landing procedures in addition:

- 1) Flaps - FULL DOWN (7GCBC)
- 2) Approach Airspeed - 60 MPH
- 3) Throttle - AS DESIRED to control rate of descent
- 4) Slip aircraft as necessary to increase rate of descent

WARNING

A relatively high rate of descent is possible in this configuration when at full gross weight and the throttle closed. If airspeed is allowed to decrease below 60 MPH, level off can only be assured with an application of power.

SHUTDOWN

- 1) Brakes - SET
- 2) Electrical Equipment - OFF
- 3) Mixture - IDLE CUT-OFF
- 4) Magnetos/Master Switch - OFF after propeller stops
- 5) Controls - SECURE with lap belt around forward control stick only
- 6) Wheels - CHOCKED
- 7) Wing/Tail Tie Downs - SECURE

NOTE

If high winds are anticipated, the aircraft should be hangared. If the aircraft must be left out, park into the wind and use additional tie-down ropes for security. Place the flaps in the FULL DOWN position (7GCBC) and secure the forward control stick with the lap belt.

SECTION IV

FLIGHT PERFORMANCE

INDEX

GENERAL	4-1
AIRSPEED CORRECTION	4-2
STALL SPEEDS.	4-3
TAKE-OFF PERFORMANCE.	4-4
CLIMB PERFORMANCE	4-4
CRUISE PERFORMANCE	
7ECA	4-5
7CAA.	4-6
7CAB.	4-6
7CBC.	4-7
LANDING PERFORMANCE	4-8

GENERAL

This data is to inform the pilot what he can expect from the aircraft in the way of performance and to assist in preflight planning.

Flight performance data is included for all Citabria models. The data has been compiled from both estimated calculations and actual flight test using average piloting techniques, with an aircraft and engine in good operating conditions. All information is corrected for standard atmospheric conditions.

Performance may vary from the given data due to the many possible variables present with a specific aircraft and flight condition. The pilot is therefore encouraged to maintain a personal flight log for his aircraft. This will not only provide more accurate preflight planning information for future flights, but also can be used as an indicator in determining the general condition of a particular aircraft.

WARNING

Flight performance between the different Citabria models varies significantly. This manual includes the performance data for all models. It is the pilot's responsibility to insure that the correct performance chart is used for a specific Citabria model.

AIRSPEED CORRECTION

I.A.S. (MPH)	C.A.S. (MPH)
50	58
60	66
70	75
80	83
90	92
100	100
110	109
120	117
130	125
140	134
150	142
160	150
170	159

- NOTES: 1) Assumes zero instrument error.
 2) 7GCBC flaps up.
 3) Maximum gross weight of 1650 lbs. at the forward C.G. limit.

STALL SPEEDS — MPH CAS

MODELS	ANGLE OF BANK			
	0°	20°	40°	60°
7ECA	51	53	58	72
7KCAB	51	53	58	72
7GCAA	51	53	58	72
7GCBC FLAPS ↑	50	52	57	71
7GCBC FLAPS ↓	45	46	51	64

- NOTES: 1) Gross Weight 1650 Lbs.
 2) Power Off.

TAKE-OFF/CLIMB PERFORMANCE

MODEL		7ECA			7GCBC			7GCAA, 7KCAB	
Press Alt Ft.	Temp (°F)	T.O. Dist Ft.	50 Ft. Obst Ft.	R/C	T.O. Dist Ft.	50 Ft. Obst Ft.	R/C	T.O. Dist Ft.	50 Ft. Obst Ft.
S.L.	0	340	716	800	231	457	1240	289	535
	20	372	768	775	254	491	1210	317	574
	40	415	832	750	279	530	1170	350	618
	60	455	895	725	305	567	1145	382	663
	80	496	961	700	340	616	1110	417	713
	100	544	1034	675	363	649	1090	453	763
2000	0	407	860	685	272	536	1100	343	622
	20	444	929	660	294	573	1070	376	671
	40	492	1004	635	331	629	1030	414	727
	60	543	1086	610	374	684	1010	452	784
	80	597	1174	585	397	733	980	497	846
	100	655	1269	560	433	777	950	538	904
4000	0	482	1043	575	324	635	980	401	738
	20	538	1147	545	360	695	930	448	806
	40	589	1239	520	393	746	900	479	857
	60	640	1329	495	458	834	870	527	925
	80	690	1432	470	474	870	840	573	991
	100	788	1580	450	522	935	820	643	1086
6000	0	576	1301	465	385	763	840	479	886
	20	640	1432	435	421	827	800	529	962
	40	707	1562	410	472	905	770	582	1040
	60	789	1716	385	522	981	740	647	1133
	80	858	1858	365	568	1048	720	706	1226
	100	968	2058	340	626	1137	690	760	1304
8000	0			350			700		
	20			325			670		
	40			300			640		
	60			275			610		
	80			245			580		
	100			225			550		

- 1) All performance at maximum gross weight 1650 lbs.
- 2) Take-off performance on dry pavement.
- 3) 7GCBC with 14° flaps.

MODEL 7ECA ——— CRUISE PERFORMANCE ——— ZERO WIND

ALTITUDE FEET	RPM	% BHP	TAS MPH	GPH	ENDURANCE HOURS	RANGE STATUTE MI.
2500	2800	90	122	9.6	3.6	445
	2700	76	117	8.0	4.4	510
	2600	66	113	5.9	5.9	670
	2500	59	108	5.2	6.7	725
	2400	53	104	4.7	7.4	770
	2300	49	100	4.3	8.1	810
	2200	45	96	4.0	8.8	840
	2100	42	92	3.7	9.5	870
	2000	40	88	3.5	10.0	880
	5000	2800	83	123	8.9	3.9
2700		72	118	6.3	5.6	655
2600		63	114	5.6	6.3	710
2500		56	108	4.9	7.1	770
2400		51	104	4.5	7.8	805
2300		47	99	4.1	8.5	845
2200		43	94	3.8	9.2	865
2100		40	90	3.6	9.7	875
7500	2800	77	124	8.2	4.3	525
	2700	67	119	5.9	5.9	705
	2600	60	114	5.2	6.7	765
	2500	53	109	4.7	7.4	810
	2400	48	103	4.3	8.1	835
	2300	44	98	3.9	9.0	875
	2200	41	92	3.6	9.7	890
	10000	2800	70	124	6.2	5.6
2700		62	119	5.5	6.4	755
2600		56	114	4.9	7.1	810
2500		50	107	4.4	8.0	855
2400		46	101	4.0	8.8	880
2300		42	93	3.7	9.5	880

- NOTES: 1) Maximum cruise is normally limited to 75% power.
- 2) All fuel consumption estimates are based on the recommended lean mixture when at or below 75% power and full rich above 75% power.
- 3) No fuel allowance is made for take-off, climb, descent or reserve.
- 4) All performance figures based on maximum gross weight of 1650 lbs.
- 5) Cruise performance using McCauley Propeller 1C90CLM72-46 only

ALTITUDE FEET	RPM	% BHP	TAS MPH	GPH	ENDURANCE HOURS	RANGE STATUTE
2500	2700	81	130	11.6	3.0	390
	2600	74	126	8.5	4.1	515
	2500	66	121	7.6	4.6	555
	2400	59	116	6.8	5.1	590
	2300	53	111	6.1	5.7	630
	2200	46	104	5.3	6.6	685
	2100	40	98	4.6	7.6	745
	2000	35	90	4.0	8.7	785
5000	2700	76	130	10.8	3.2	415
	2600	69	126	8.7	4.0	500
	2500	62	121	7.1	4.9	590
	2400	55	115	6.4	5.5	630
	2300	49	110	5.7	6.4	700
	2200	43	103	5.0	7.0	720
	2100	38	97	4.4	7.9	765
	2000	33	88	3.8	9.2	810
7500	2700	70	130	8.1	4.3	555
	2600	64	125	7.3	4.8	600
	2500	57	118	6.6	5.3	625
	2400	51	114	5.9	5.9	670
	2300	46	108	5.2	6.7	720
	2200	41	102	4.7	7.4	755
	2100	36	94	4.1	8.5	795
	2000	32	84	3.6	9.7	815
10000	2700	65	128	7.4	4.7	600
	2600	59	124	6.7	5.2	645
	2500	53	118	6.1	5.7	673
	2400	47	112	5.4	6.5	725
	2300	42	105	4.8	7.3	765
	2200	38	98	4.3	8.1	790
	2100	33	89	3.8	9.2	815

- NOTES: 1) Maximum cruise is normally limited to 75% power.
- 2) All fuel consumption estimates are based on the recommended lean mixture when at or below 75% power and full rich above 75% power.
- 3) No fuel allowance is made for take-off, climb, descent or reserve.
- 4) All performance figures based on maximum gross weight of 1650 lbs.
- 5) Cruise performance using Sensenich Propeller 74DM6S8-1-56 only.

MODEL 7GCBC ——— CRUISE PERFORMANCE ——— ZERO WIND

ALTITUDE FEET	RPM	% BHP	TAS MPH	GPH	ENDURANCE HOURS	RANGE STATUTE MI.
2500	2700	81	128	11.6	3.0	380
	2600	74	124	8.5	4.1	505
	2500	66	119	7.6	4.6	545
	2400	59	114	6.8	5.1	580
	2300	53	109	6.1	5.7	620
	2200	46	103	5.3	6.6	680
	2100	40	96	4.6	7.6	730
	2000	35	89	4.0	8.7	770
5000	2700	76	128	10.8	3.2	410
	2600	69	124	8.7	4.0	495
	2500	62	119	7.1	4.9	580
	2400	55	114	6.4	5.5	625
	2300	49	108	5.7	6.4	690
	2200	43	102	5.0	7.0	710
	2100	38	96	4.4	7.9	755
	2000	33	86	3.8	9.2	790
7500	2700	70	128	8.1	4.3	550
	2600	64	123	7.3	4.8	590
	2500	57	116	6.6	5.3	615
	2400	51	113	5.9	5.9	665
	2300	46	106	5.2	6.7	710
	2200	41	100	4.7	7.4	740
	2100	36	93	4.1	8.5	790
	2000	32	83	3.6	9.7	805
10000	2700	65	126	7.4	4.7	590
	2600	59	122	6.7	5.2	630
	2500	53	117	6.1	5.7	665
	2400	47	111	5.4	6.5	720
	2300	42	104	4.8	7.3	755
	2200	38	97	4.3	8.1	785
	2100	33	88	3.8	9.2	810

- NOTES: 1) Maximum cruise is normally limited to 75% power.
 2) All fuel consumption estimates are based on the recommended lean mixture when at or below 75% power and full rich above 75% power.
 3) No fuel allowance is made for take-off, climb, descent or reserve.
 4) All performance figures based on maximum gross weight of 1650 lbs.
 5) Cruise performance using Sensenich Propeller 74DM6S8-1-56 only.

LANDING DISTANCE

GROSS WEIGHT = 1650 POUNDS - POWER OFF - HARD DRY SURFACE RUNWAY - ZERO WIND

MODEL	APPROACH SPEED (IAS)	Sea Level - 59° F		2500 Ft. - 50° F		5000 Ft. - 41° F		7500 Ft. - 32° F	
		Ground Roll	Total To Clear 50 Ft. Obstacle	Ground Roll	Total To Clear 50 Ft. Obstacle	Ground Roll	Total To Clear 50 Ft. Obstacle	Ground Roll	Total To Clear 50 Ft. Obstacle
	MPH	FT.	FT.	FT.	FT.	FT.	FT.	FT.	FT.
7GCBC	60	310	690	335	715	360	740	390	770
7GCAA	60	400	755	430	785	465	820	500	855
7KCAB	60	400	755	430	785	465	820	500	855
7ECA	60	400	775	430	805	465	840	500	875

- NOTES: 1) Decrease the distances shown by 10% for each 5 knots of headwind.
 2) The data given for the Model 7GCBC is with flaps fully extended.

SECTION V

WEIGHT AND BALANCE

INDEX

GENERAL	5-1
LOADING PROCEDURES	5-2
SAMPLE LOADING PROBLEM	5-3
LOADING GRAPH	5-4
FLIGHT ENVELOPE(S)	5-5, 6, 7

GENERAL

It is the pilot's responsibility to insure that the aircraft is loaded properly and within the weight and balance limitations. All flight performance, procedures and characteristics are based on this prerequisite.

If the aircraft is to be used for aerobatic flight, it must be loaded within the approved flight envelope. The rear center of gravity limit is considered critical. In addition, no baggage is allowed.

Although the gross weight limit is not affected by aerobatic flight, the importance of this limit cannot be overemphasized. Subjecting the aircraft to the maximum approved load factor limits in an overgross condition may result in damage or complete structural failure of the airframe.

The actual licensed empty weight and center of gravity (C.G.) of a specific aircraft can be found on the Weight and Balance Form and the Operating Limitations Card, both of which are a permanent part of the aircraft's file. All additional changes to the aircraft's empty weight and C.G. after the time of manufacture must also be attached to or indicated on both forms. From this information and the following instructions, the pilot can easily determine the "Useful Load" and proper loading distribution for the aircraft.

NOTE

The rear center of gravity limits vary with each model Citabria. A flight envelope is provided for each model.

LOADING PROCEDURES

1. Determine from the Weight and Balance Sheet, in the aircraft file, the "Licensed Empty Weight and Moment" (in-lbs). Enter these figures under "Your Airplane" of the Sample Loading Problem, Figure 5-1.
2. Full oil capacity can be assumed for all flights. For ease of future loading computations, the new "Empty Weight and Moment with Oil" should be determined and entered in the Sample Loading Problem under "Your Airplane".
3. Using the Loading Graph, Figure 5-2, determine the weight and the moment of the following items and enter these figures on the Sample Loading Problem.
 - a) Pilot
 - b) Rear Passenger
 - c) Wing Fuel - 35 Gals. Maximum Usable @ 6 Lbs./Gal.
 - d) Baggage - 100 Lbs. Maximum (Normal Category Only)
4. Add the "Aircraft Empty Weight and Moment with Oil" and all the items in Step 3 to determine the "Gross Take-Off Weight and Moment".
5. Using the Flight Envelope, Figures 5-3, 5-4, 5-5 for the model Citabria used, determine that the gross take-off weight and moment are within limits.

WARNING

If the aircraft is not within the approved flight envelope limits, it must be reloaded. Under no circumstances should the aircraft be flown with an out of limits condition, particularly if aerobatic flight is contemplated.

SAMPLE LOADING PROBLEM

ITEM	ARM (in)	SAMPLE AIRPLANE		YOUR AIRPLANE	
		WEIGHT (lbs)	MOMENT (in-lbs)	WEIGHT (lbs)	MOMENT (in-lbs)
1) Licensed Empty Weight	12.2	1153	14067		
Oil-8 qts @ 7.5 lbs/gals *7ECA--6 qts	-36.0	+15	-540	+15 (+11*)	-540 (-396*)
2) Licensed Empty Weight & Moment With Oil		1168	13527		
3) Pilot	11.5	190	2185		
Rear Passenger	42.0	190	7980		
Wing Fuel - 35 Gals Max @ 6 lbs/gal	24.5	102	2499		
Baggage-100 lbs Max (Normal Category Only)	69.0	-0-	-0-		
4) Gross Take-Off Weight & Moment		1650	26191		

- NOTE: 1) * 7ECA only - 6 qts oil.
 2) To determine Take-Off Center of Gravity (inches aft of datum) divide the Gross Take-Off Moment by the Gross Take-Off Weight. Center of Gravity Limits are listed in Section I.
 3) The above sample problem is loaded for aerobatic flight conditions and assumes a 170 pound pilot and passenger with parachutes.

FIGURE 5-1 SAMPLE LOADING PROBLEM

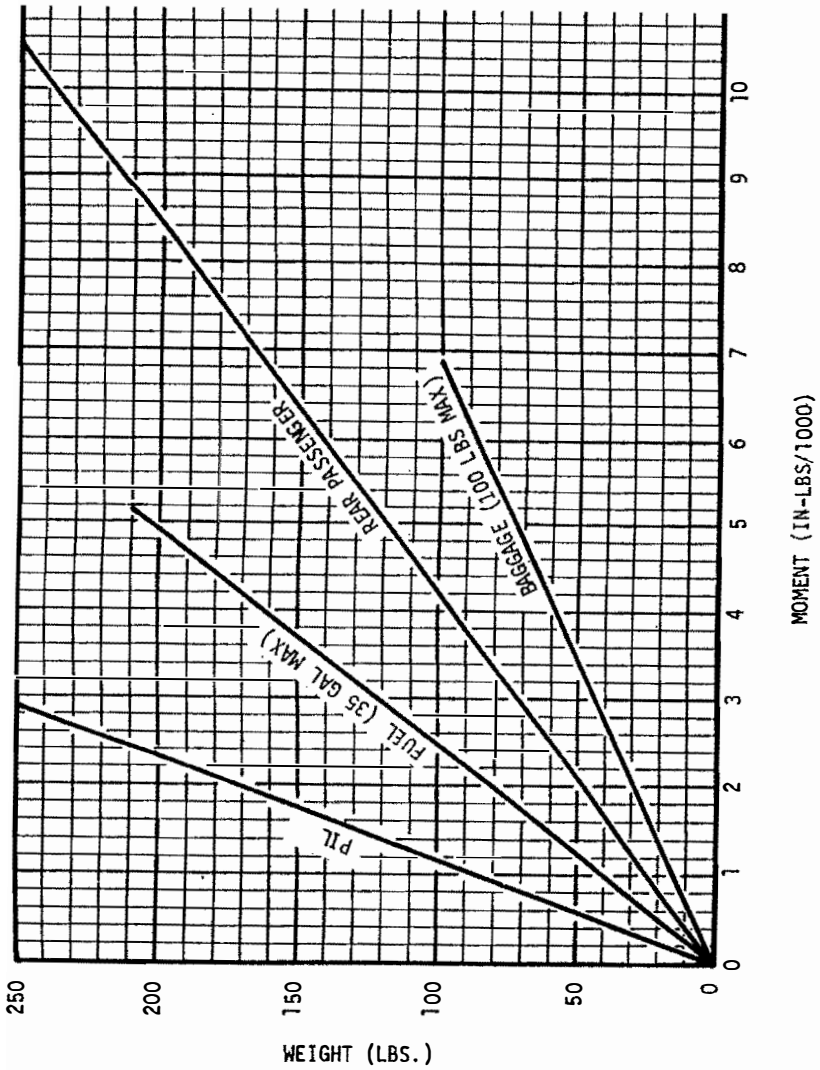

FIGURE 5-2 LOADING GRAPH (ALL MODELS)

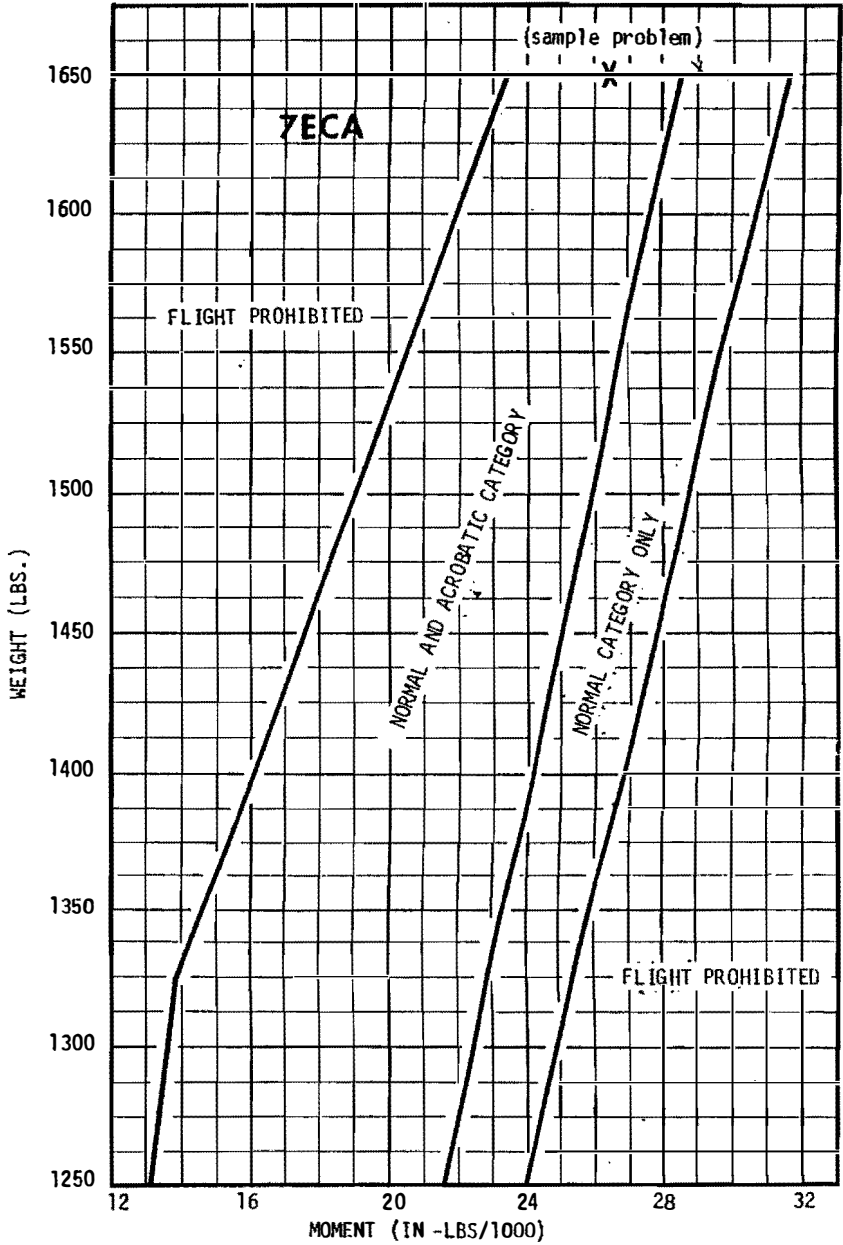

FIGURE 5-3 FLIGHT ENVELOPE - 7ECA ONLY

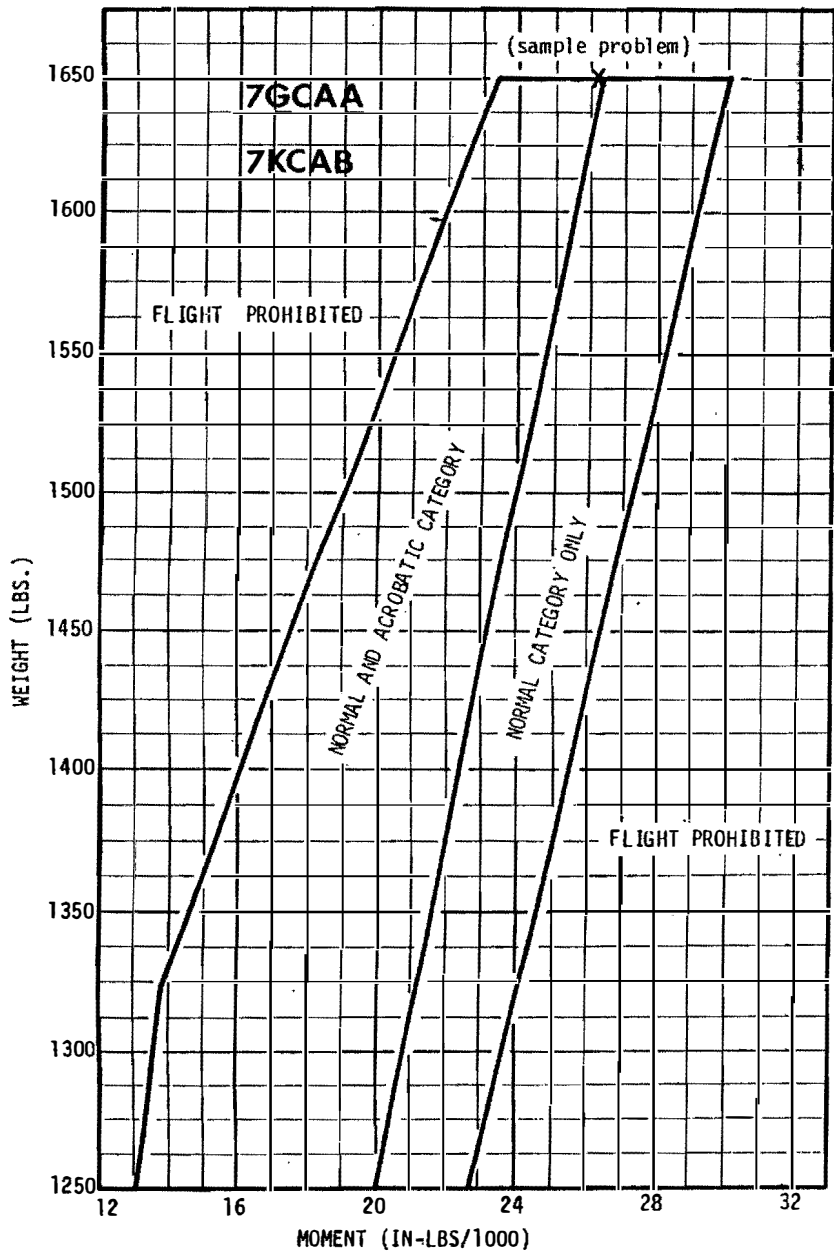

FIGURE 5-4 FLIGHT ENVELOPE - 7GCAA, 7KCAB ONLY

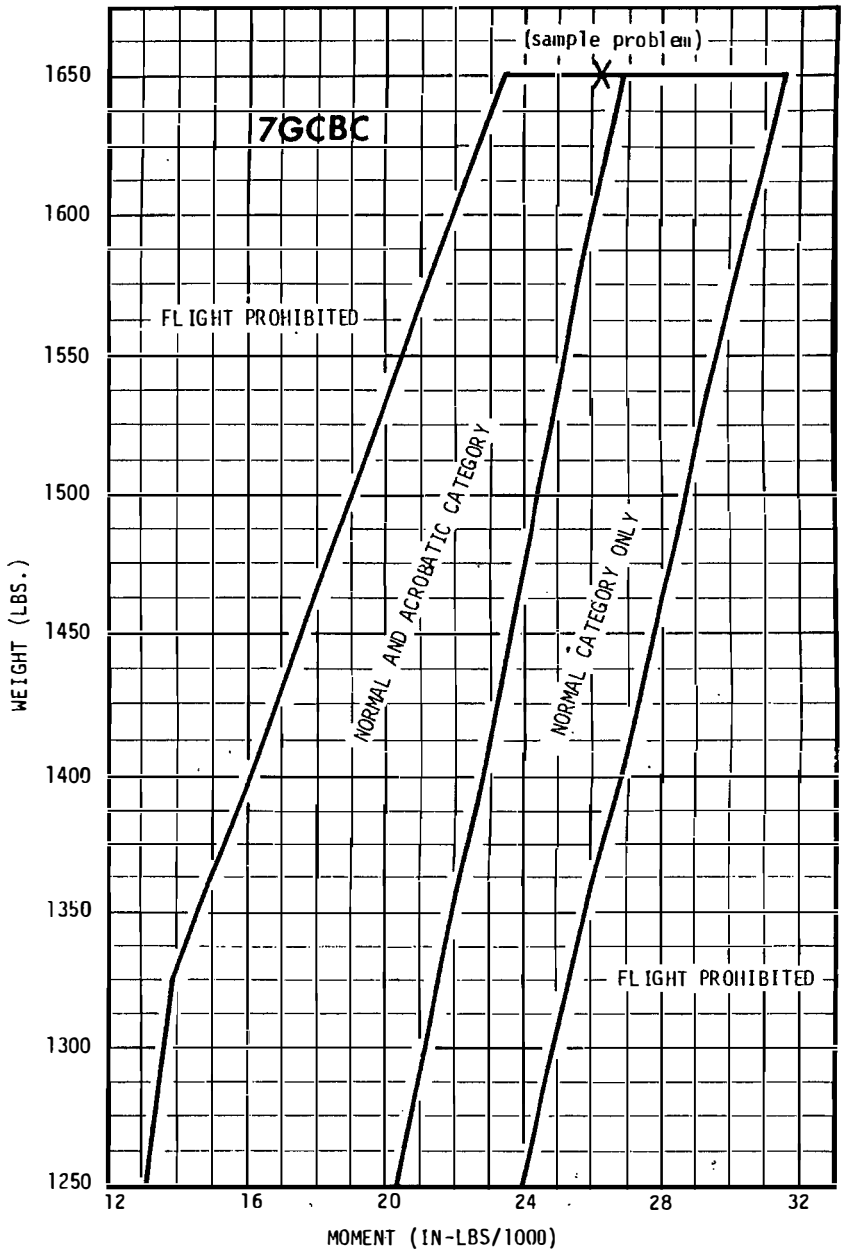

FIGURE 5-5 FLIGHT ENVELOPE - 7GCBC ONLY



SECTION VI

AIRCRAFT AND SYSTEMS DESCRIPTION

INDEX

GENERAL	6-1
AIRCRAFT FILE	6-4
AIRFRAME STRUCTURE.	6-4
ENGINE.	6-5
FLIGHT CONTROLS	6-7
FLAPS (7GCBC ONLY).	6-7
LANDING GEAR AND BRAKES	6-8
ELECTRICAL SYSTEM	6-8
FUEL SYSTEM	6-10
HEATING AND VENTILATION	6-13
AIRCRAFT LIGHTING	6-13
FLIGHT INSTRUMENTS.	6-13
AVIONICS.	6-14
CABIN FEATURES.	6-15
UTILITY OPTIONS	6-15
CORROSION PROOFING	6-15
SEAPLANE KIT	6-16
GLIDER/BANNER TOW.	6-16

GENERAL

This section describes the aircraft, systems and equipment. Because of the many optional items available, this section may not be typical for all aircraft. However, the more popular options available from the factory will be described. Consult the Aircraft Equipment List to determine what equipment is installed on a specific aircraft.

MODEL NUMBER	7ECA	7GCAA	7KCAB	7GCBC
FAA TYPE CERTIFICATE	A-759	A-759	A-759	A-759
ENGINE, LYCOMING	0-235-C1	0-320-A2B, -A2D	AE10-320- E2A, -E2B	0-320-A2B -A2D
HORSEPOWER (hp/rpm)	115/2800	150/2700	150/2700	150/2700
PROPELLER DIAMETER (in)	72	72	72	72
GROSS WEIGHT (lbs)	1650	1650	1650	1650
POWER LOADING (lbs/hp)	14.3	11.0	11.0	11.0
BASIC EMPTY WEIGHT (lbs)	1060	1110	1137	1150
USEFUL LOAD (lbs)	590	540	513	500
WING AIRFOIL (NACA)	4412	4412	4412	4412
WING SPAN (ft)	33.38	33.38	33.38	34.45
CHORD (in)	60	60	60	60
WING AREA (sq-ft)	165	165	165	170
WING LOADING (lbs/sq-ft)	10.0	10.0	10.0	9.7
ASPECT RATIO	6.7	6.7	6.7	6.9
DIHEDRAL	2°	2°	2°	2°
ANGLE OF INCIDENCE	1°	1°	1°	1°
LENGTH (ft)	22.77	22.77	22.77	22.77
HEIGHT (3 Point) (ft)	7.75	7.75	7.75	7.75
WHEEL TREAD WIDTH (in)	78	78	78	78
WHEEL BASE (ft)	16.19	16.19	16.19	16.19
FUEL CAPACITY (Usable-gals)	35	35	35	35
OIL CAPACITY (qts)	6	8	8	8

FIGURE 6-1 AIRCRAFT SPECIFICATIONS

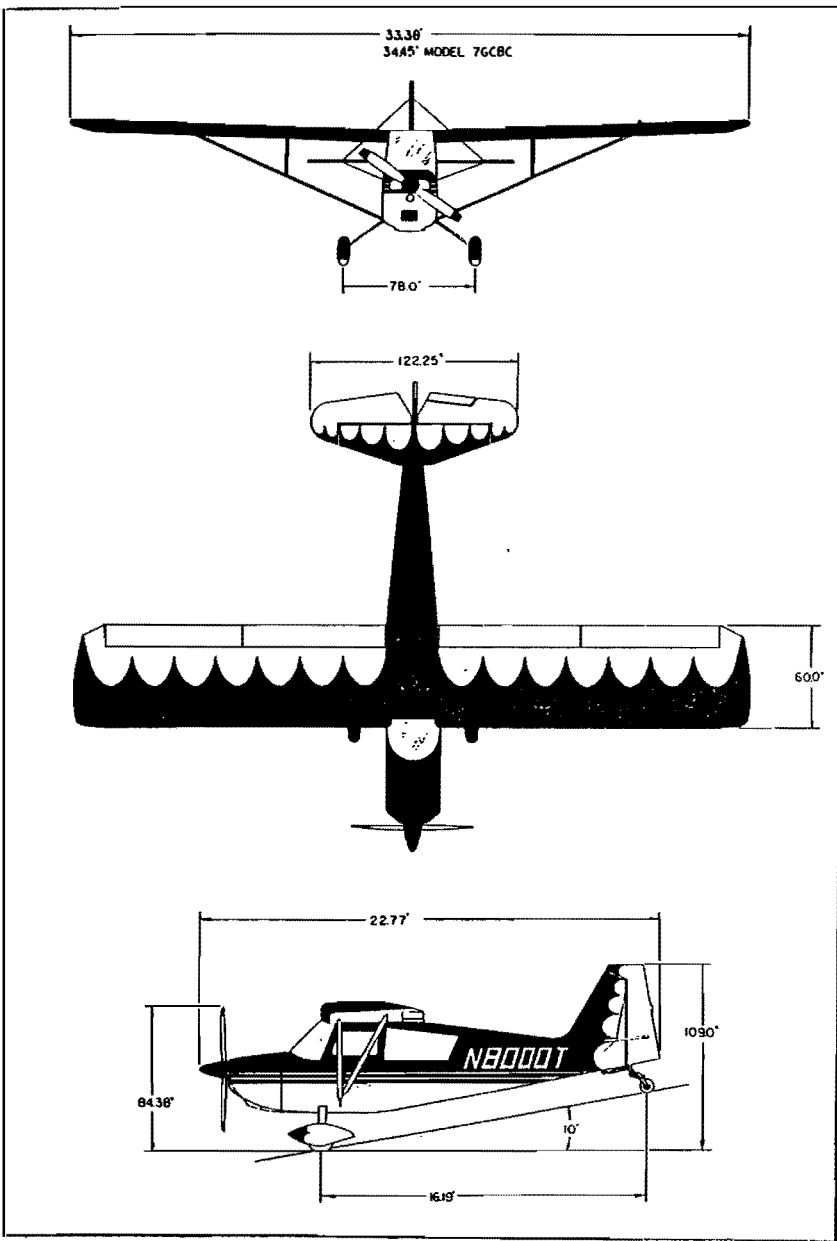

FIGURE 6-2 CITABRIA THREE-VIEW

AIRCRAFT FILE

The aircraft file includes the required paperwork that must be in the aircraft or available upon request. These items will reference the aircraft by serial number, model number and registration number. The aircraft identification plate, which also contains this information, is located on the cabin floor to the left and forward of the rear seat. The file consists of the following items:

These items must be displayed inside the aircraft.

- 1) Airworthiness Certificate
- 2) Aircraft Registration
- 3) Aircraft Radio License (if radio installed)
- 4) Operating Limitations Placards and Markings

These items must be in the aircraft but need not be displayed.

- 1) Aircraft Equipment List
- 2) Weight and Balance Sheet

These items need not be carried in the aircraft but must be available upon request.

- 1) Engine Log Book
- 2) Aircraft Log Book

NOTE

The Pilot's Operating Manual should always be carried in the aircraft readily available to the pilot during flight but is not legally required.

AIRFRAME STRUCTURE

The Citabria is a two place, tandem seating, high wing aircraft with conventional landing gear. See Figures 6-1 and 6-2 respectively for the principal dimensions and specifications and an external three-view of the aircraft. All components are designed to meet or exceed the requirements set forth by the Federal Aviation Administration.

The fuselage and empennage are constructed of welded tubular steel providing high strength and pilot protection under all conditions. The entire assembly is protected by an epoxy primer and covered with a heavy fire resistant dacron fabric. The life-time dacron is finished with several coats of pigmented dope which is durable, long lasting and easy to care for. The streamlined fiberglass engine cowl is a two piece, split type for easy removal providing complete access to the engine for servicing.

The wing structure includes two spruce spars, each supported by strut: providing a high strength to weight ratio. The wing ribs and the leading edge are aluminum and covered with dacron. The finish is identical to the fuselage.

ENGINE

The Citabria is powered by a carbureted (7KCAB--fuel injected), Lycom four cylinder, horizontally opposed, direct drive engine. The all metal, fixed pitch propeller is designed to give good take-off and cruise performance.

The wet sump oil system is conventional with the pressure and temperature automatically controlled by an internal engine driven gear pump and external oil cooler (7ECA has no cooler).

The 7KCAB only, has in addition to the conventional oil system, full inverted capabilities. See Figure 6-3 for the system schematic and detailed operational information.

Oil temperature and pressure gauges are the direct reading type requiring no electric power. Oil quantity is determined by a dip stick with access through the inspection door on the right side of the engine cowl.

Ignition is provided by two engine magnetos which are independent of the aircraft electrical system and each other. Separate magneto switches are located on the electrical panel mounted on the upper left side of the cabin between the two seats.

Starting is accomplished by an electric geared cranking motor using the aircraft battery. The starter button is located in the lower center of the instrument panel.

Dual throttle controls are located on the left side of the cabin for both the front and rear seats.

The red (push-pull) mixture control is located on the left side of the instrument panel and is used for fuel leaning and engine shutdown. Idle cut-off is accomplished by pulling the control full out.

NORMAL FLIGHT OPERATION

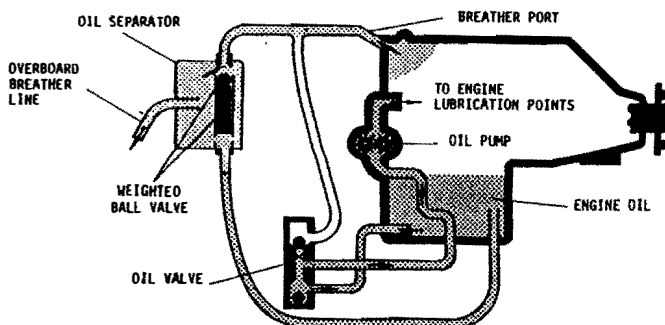

During normal flight, the weighted ball valve at the top of the oil separator is open allowing blowby gases from the engine crankcase to be vented from the breather port, to the oil separator and out through the overboard breather line. The top port of the oil valve is closed and the bottom port is open allowing oil to flow from the sump out through the oil valve, up to the pump and out to the engine lubrication points.

NOTE

Momentary oil pressure interruptions (up to a maximum of 15 seconds) is normal when the system is initially returned to normal operation from inverted flight.

INVERTED FLIGHT OPERATION

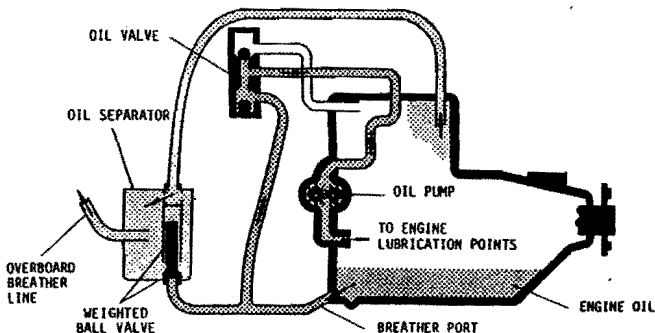

When the aircraft is inverted, engine oil falls to the top of the crankcase. The weighted ball valve in the oil separator closes permitting the engine oil pump to draw oil through the oil valve from the crankcase and preventing overboard loss of oil through the oil separator. Blowby gases from the engine crankcase are vented from the sump to the oil separator and out through the overboard breather line. The top port of the oil valve is open and the bottom port is closed allowing oil to flow out from the breather port, to the oil valve, to the oil pump and out to the engine lubrication points. Any oil in the lines which falls to return to the sump during the transition between normal and inverted flight drains into the oil separator. This oil then returns to the sump from the bottom of the oil separator during periods of normal flight.

NOTE

Momentary oil pressure interruptions (up to a maximum of 15 seconds) is normal when the system is initially inverted.

FIGURE 6-3 INVERTED ENGINE OIL SYSTEM (7KCAB ONLY)

The air induction system is equipped with a large heavy duty air filter mounted in front of the engine cowling. Carburetor heat (Alternate Air-7KCAB) is available from the exhaust manifold if carburetor icing conditions exist. The carburetor heat control is located below the throttles. Maximum heat is applied with the control in the aft position. The aft position also by-passes the air filter should it become obstructed with ice or dirt.

NOTE

With the carburetor heat in the HOT position, the induction air to the engine is unfiltered. To prevent damage to the engine, it should not be used during ground operations except for an operational check of system prior to flight.

Engine RPM is indicated by a mechanical tachometer using a flexible drive cable. An hour meter, based on cruise RPM, is incorporated in the tachometer. The electrical hour meter (Hobbs meter) indicates the actual running time of the engine and is activated by engine oil pressure.

FLIGHT CONTROLS

Dual controls are provided for the ailerons, elevator and rudder. The balanced control surfaces are conventional in design and are mechanically connected to a control stick and rudder pedals using cables and/or push-pull rods. Low friction bearings are used extensively throughout the system to reduce control pressures.

An elevator trim tab is mounted on the left elevator. The trim control is located on the left side of the cabin between the two seats. Take-off position is indicated by a white dot on the control quadrant.

Rudder trim is provided by a ground adjustable tab located on the rudder control surface.

FLAPS (7GCBC ONLY)

Wing flaps are mechanically operated by cables and interconnected by a torque tube. The flap handle is located to the left of the pilot. Flap settings of 0°, 7°, 14°, 21°, 27° and 35° are available by pulling the handle aft. A red release button is located on the end of the flap handle for retraction. No UP lock is provided.

LANDING GEAR AND BRAKES

The heavy duty spring steel conventional landing gear allows routine operations on rough landing strips. The steerable Scott tail wheel allows excellent directional control during taxi operations with the use of wheel springs which are attached to the rudder control surface. The tail wheel also provides free swiveling of 360° allowing the aircraft to be turned within its own wing span.

Hydraulic disc brakes are mounted to each main wheel. The brakes can be operated separately from either seat by applying heel pressure on the brake pedals or toe pressure on the top of the rudder pedals if toe brakes are installed.

The brake hydraulic reservoir is mounted to the aft side of the firewall for easy access. A clear plastic line between the reservoir and the master cylinders is visible from the pilot's seat indicating a low fluid condition.

The park brake control is located to the right and under the instrument panel. To set the brakes, pull the park brake control out and apply brake pressure. To release the brakes, push the park brake control in.

ELECTRICAL SYSTEM

The electrical system is 12 volts, direct current, using the airframe as a negative ground. See Figure 6-4. All electrical circuits are protected by replaceable fuses.

A 60 ampere, self-exciting, engine driven alternator provides electrical power during normal operations and is capable of operating all electrical components simultaneously. The voltage regulator maintains a system voltage of $14 \pm .5$ volts.

The 7KCAB only has a gravity sensitive mercury switch which disconnects the alternator from the battery during inverted or negative G flight maneuvers. This prevents pressure buildup in the battery which could result in damage to the battery or acid spillage.

A lead-acid battery supplies power for starting and stand-by use for a limited time only should the alternator fail in flight.

An ammeter on the instrument panel indicates a charge or discharge condition of the battery. With the alternator functioning normally, a slight charge condition should exist depending on the condition of the battery. A discharge indicates that an alternator malfunction exists and the battery is carrying the electrical load.

NOTE

A discharge is normal at low idle RPM during operation of high current items such as the landing light.

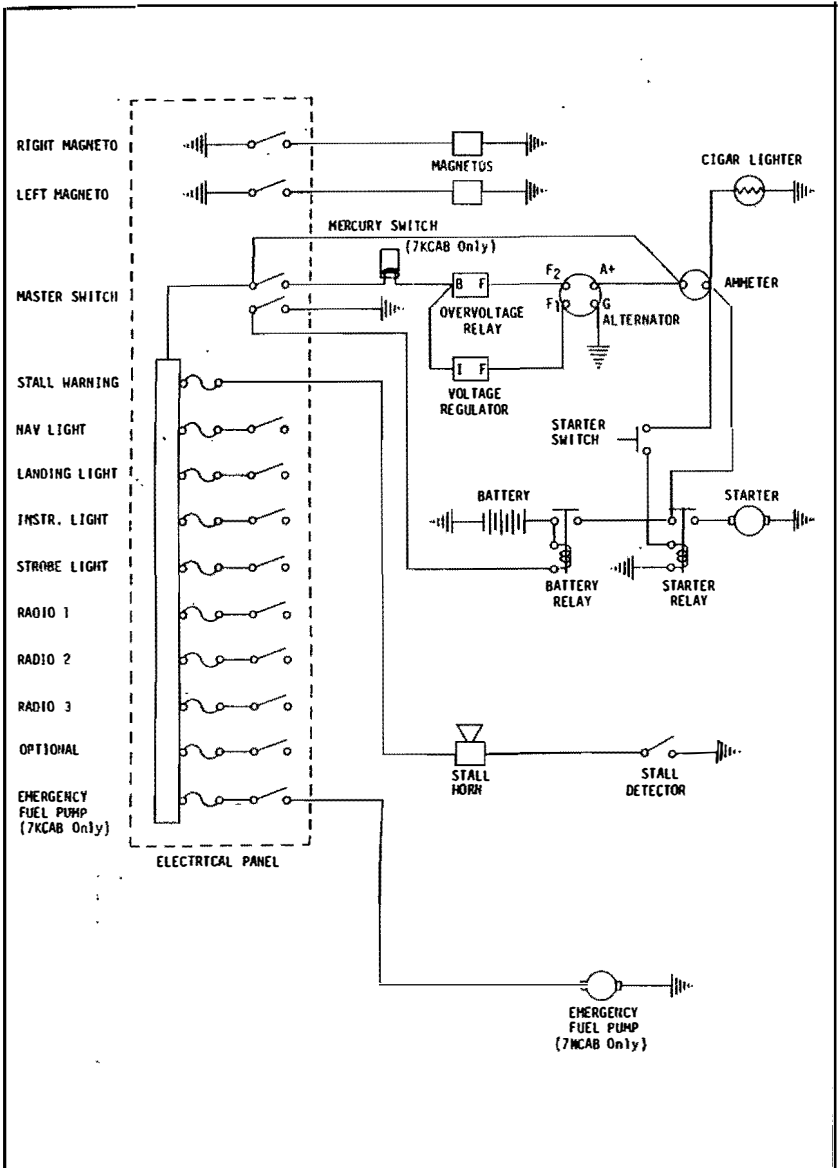

FIGURE 6-4 ELECTRICAL SYSTEM SCHEMATIC

All electrical switches and fuses are located on the electrical panel which is installed on the upper left side of the cabin. Additional spare fuses are also provided in the panel and can be used for replacement during flight if necessary.

A red master switch controls all electrical power from the battery and alternator to the distribution bus with the exception of the engine magnetos.

NOTE

Failure to turn the master switch OFF after securing the aircraft will result in a complete discharge of the battery.

The alternator circuit includes an overvoltage relay which automatically removes it from the circuit to prevent damage to the alternator or the radio equipment should an overvoltage condition occur. Cycling the master switch will reset the overvoltage relay should it drop the alternator off the circuit due to an overvoltage condition. This is indicated by a discharge on the ammeter. After resetting, if the overvoltage condition was temporary, the alternator will continue to operate normally.

FUEL SYSTEM

The Citabria fuel system is completely independent from the other aircraft systems and due to its simplicity is virtually trouble free. See Figure 6-5.

Fuel is supplied from two interconnected wing tanks and is gravity fed to the engine carburetor (fuel injector--7KCAB). Fuel quantity is registered by two direct reading float-type gauges, one for each tank. They are located in each wing root area of the cabin.

NOTE

Correct fuel indication is only provided with the aircraft in level flight attitude.

The fuel shut-off valve is located on the lower left side of the cabin forward of the pilot. Two positions are available, ON or OFF. A gascolator is mounted to the firewall with a quick drain feature provided. The quick drain control knob is located through the inspection door on the engine cowl. An additional drain is located under the fuselage aft of the baggage compartment and is easily accessible during the preflight inspection.

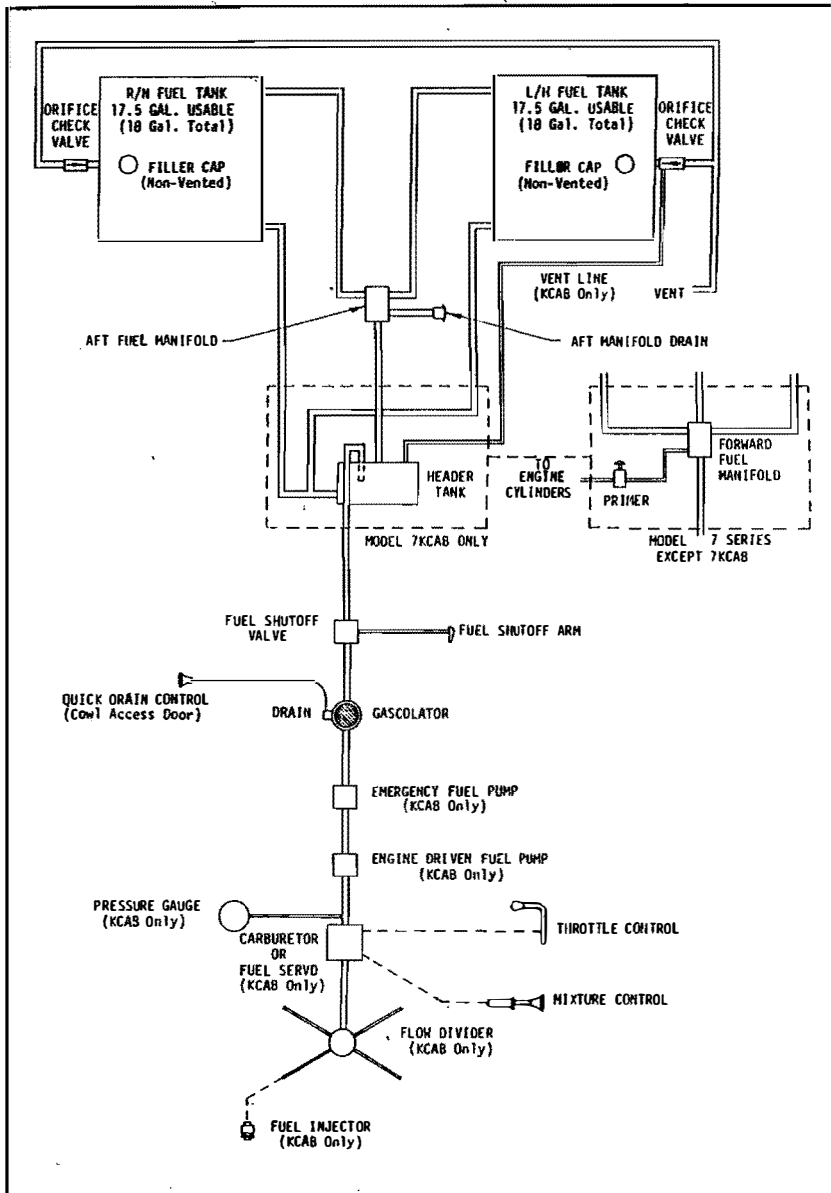

FIGURE 6-5 FUEL SYSTEM SCHEMATIC

The fuel tanks are vented together with the vent located on the left wing. An orificed one-way check valve allows a minimum of fuel to be vented overboard during negative G aerobatic maneuvers. An ice deflector is provided to aid in preventing vent obstruction should the aircraft inadvertently encounter icing conditions.

WARNING

The fuel caps are the non-vented type. Failure to properly secure the caps will result in fuel leakage and unequal fuel feed between the two tanks during flight.

An engine fuel primer is located on the instrument panel to facilitate starting. Turn the knob to release the plunger then pump the desired amount.

WARNING

After using the primer, insure that the knob is locked in place to prevent additional fuel from entering the engine cylinders.

The 7MCAB only, is fuel injected and has additional provisions for limited inverted flight. See Figure 6-5. This includes an engine driven fuel pump and an electric boost pump, which is used for starting and for emergency use should the engine driven pump fail. The switch is located on the electrical panel. A direct reading fuel pressure gauge is installed in the instrument panel.

A 1.5 gallon header tank is mounted aft of the firewall. A standpipe in the tank allows .75 gallons to be used for inverted flight which is approximately 2-3 minutes depending on power settings. During positive G conditions, the tank automatically refills by gravity from the main wing tanks.

WARNING

Continuous inverted flight is limited to 2 minutes. Approximately 3.5 minutes of flight under positive G conditions is required to completely refill the header tank. Temporary fuel starvation may result during an extended series of aerobatic maneuvers involving a majority of negative G conditions.

NOTE

Should fuel starvation result during inverted flight, return to positive G conditions. The engine will restart within 10 seconds.

Heat is obtained from a heat muff attached to the engine exhaust manifold. Both the front and rear seat control knobs are located on the lower left side of the instrument panel. The front seat heat outlet is on the left side of the firewall and the rear seat outlet is mounted to the cabin floor between the two seats.

Fresh air is obtained by two rotatable air scoops on both sides of the cabin forward of the pilot. Adjust the scoop forward for fresh air intake and rearward for air exhaust.

Additional fresh air vents are located in the left and right wing roots. Air flow is adjusted by rotating the valve as desired.

AIRCRAFT LIGHTING

All light switches are located on the electrical panel. The interior light is located on the upper left side of the cabin. It is detachable and equipped with a long coiled chord for mobility. The light has both a clear and a red lense with an adjustable beam. The intensity is controlled by a rheostat which is located on the back of the light fixture.

The exterior lights include the standard navigation lights on the wing tips and rudder. High intensity wing tip strobe lights are optional.

. NOTE

The strobe lights should not be used during ground operations due to the high intensity having a blinding effect on other aircraft and personnel in the area. This also holds true during flight in haze or fog due to possible distraction to the pilot.

The high intensity landing/taxi light is mounted in the engine cowl below the propeller.

FLIGHT INSTRUMENTS

The flight instruments are conventional in design and are mounted in either the low or the high type panel. The high panel has ample space for a variety of gyro instruments and avionics.

The airspeed, sensitive altimeter and the vertical speed indicator are all pressure sensitive instruments operating off the pitot-static system. The pitot-static openings are attached to the right wing jury strut.

The artificial horizon and directional gyro are vacuum operated using an engine driven vacuum pump with a vacuum gauge to indicate system pressure.

The turn coordinator is electrically driven with the ON-OFF switch located on the electrical panel.

The magnetic compass, clock, outside air temperature gauge and accelerometer are all independent units requiring no external power source.

A stall warning horn, if installed, activated by a vane type switch on the leading edge of the wing is provided to warn the pilot of an approaching stall. It is pre-set for 5 to 10 MPH above the actual stalling speed with engine power at idle. The master switch must be ON for operation.

AVIONICS

The Citabria is available with a variety of navigation and communication equipment. Each radio is equipped with a separate switch on the electrical panel in addition to the switch that is an integral part of the radio. A radio speaker is mounted in the right wing root of the cabin with microphone and headset jacks on the left side of the instrument panel. Consult the respective manufacturer for specific operating instructions.

An emergency locator transmitter (ELT) is located on the right side of the baggage compartment. It is self-contained and is automatically activated to transmit a homing signal on 121.5 MHz and 243.0 MHz should the aircraft be subjected to rapid or abrupt deceleration.

For automatic activation, the switch on top of the ELT must be in the "ARM" position. The radio can be manually activated and checked by switching to the "ON" position and tuning the communication receiver to 121.5 MHz. A variable pitch tone indicates normal operation. To re-set or deactivate the ELT, place the switch in the "OFF" position then return to the "ARM" position for automatic activation.

NOTE

Maximum range of the ELT is best achieved by removing the unit from the aircraft and placing the antenna in the upright position and as high as possible.

CABIN FEATURES

The main door (two piece split-type optional) can be jettisoned in flight by removing the door pivot pins. The jettison handle is located next to the forward edge of the door and has a safety pin to prevent inadvertent jettison. To jettison the door, remove the safety pin and pull the handle UP.

Both (if equipped with split-type door) the front side windows can be opened on the ground or in flight for additional ventilation and/or aerial photography. Although a bracket is provided for the right window to secure it in the open position during ground operation, it is recommended to let the window fly free to eliminate flutter in flight.

CAUTION

Do not open the windows in flight above the approved airspeed limits as indicated on the window placards.

An overhead tinted plexiglass window is provided for improved visibility of ground references by both the pilot and passenger during aerobatic maneuvers.

The seats are equipped with folding backs and thick foam cushions. The cushions are removable to facilitate the wearing of a parachute if desired. Both seats are equipped with seat belts and shoulder harnesses.

The baggage area is located behind the rear seat and is limited to 100 lbs.

WARNING

No baggage is allowed during aerobatic flight.

The fire extinguisher, if installed, is mounted to the floor under the pilot's seat and is equipped with a quick disconnect latch. It is a dry chemical type approved for electrical and fuel fires.

UTILITY OPTIONS

CORROSION PROOFING

For improved protection against salt-water spray and most agriculture chemicals, a special corrosion proofing is available. This is in addition to the epoxy primer and external paint used on the fuselage frame.

Included in this corrosion proofing are additional primer coatings to all structural steel tubing fittings with the inside tubing surfaces oil coated. All structural aluminum is also primed with epoxy. All control cables are stainless steel.

CAUTION

If the aircraft is to be converted to floats or used for aerial chemical applications, the corrosion proofing must be applied at the time of manufacture if a normal airframe life is expected.

SEAPLANE KIT

The Citabria is certified for floats. Included in the kit is the special corrosion proofing and two additional tail fins for improved stability.

GLIDER/BANNER TOW

A glider tow is mounted on the tail wheel assembly. The positive release handle is under the front seat. To release the tow, pull the handle aft.

SECTION VII

SERVICING

INDEX

GENERAL	7-1
SERVICE SPECIFICATIONS.	7-2
GROUND HANDLING	7-3
JACKING	7-3
MOORING	7-3
INSPECTION/SERVICING ACCESS	7-4
FUEL SYSTEM	7-4
BATTERY	7-5
BRAKES.	7-5
TIRES	7-6
ENGINE LUBRICATION.	7-6
ENGINE AIR FILTER	7-6
CLEANING.	7-6
EXTERIOR SURFACE	7-6
WINDSHIELD	7-7
ENGINE	7-7
INTERIOR	7-7
STORAGE	7-7

GENERAL

This section describes ground handling, routine servicing, cleaning and storage procedures. No information is provided for making mechanical adjustments, repairs or replacement of components. Consult your nearest Bellanca Service Center for full maintenance and servicing as they have the latest factory service recommendations, experience and qualified personnel. See Figure 7-1 for all service specifications.

The FAA requires that the aircraft undergo an annual inspection performed by a properly designated individual or repair station. If the aircraft is flown for commercial reasons, as specified by FAR's, an additional inspection is required every 100 hours of operation. This must be performed by an appropriately rated mechanic. Both inspections are identical in scope.

Bellanca Aircraft Corporation recommends the 100 hour inspection interval to provide the owners with the highest degree of utilization and safety.

NOTE

This is in addition to daily preflight inspections and routine servicing (e.g. oil change, etc.)

FUEL

Type - Aviation Grade 80/87 Minimum Octane, or 100/130 Octane
Quantity - 36 Gals. (18 gals, in each tank)
- 35 Gals. Usable (17.5 gals, in each tank)
(100/130 must be low lead for 7ECA)

OIL

Type - Aviation Grade (See engine manufacturer's specifications)
Quantity - 8 Qts. (6 qts. - 7ECA)
- 6 Qts. Aerobatic Minimum

Viscosity.

AVERAGE AMBIENT AIR TEMPERATURE	GRADE
Above 60 ⁰ F	SAE 40 or 50
30 ⁰ - 90 ⁰ F	SAE 40
0 - 70 ⁰ F	SAE 30 or 40
Below 10 ⁰ F	SAE 30

BRAKES

Type - Fluid MIL-H-5606 (red)

TIRES

Type - Mains - 6.00 x 6 (4 ply rating)
Tail - 2.80 x 2.50 (4 ply rating)

Pressure - Mains - 24 \pm 4 psi
Tail - 40 \pm 10 psi

LUBRICATION

Type - General Purpose Grease (zerke fittings)
Machine Oil or Engine Oil (pulleys, hinges, etc.)
High Temperature Wheel Bearing Grease (wheel bearings)

FIGURE 7-1 SERVICE SPECIFICATIONS

GROUND HANDLING

The Citabria can be easily maneuvered by one man when on firm level ground. A hand hold is provided on the right side of the fuselage forward of the tail. The tail can be lifted completely off the ground or the tail wheel steering can be disengaged with a sufficient side load for free casting. If additional manpower is required, use the forward wing strut applying force close to the fuselage attach fitting.

JACKING

The tail can be lifted by hand with a suitable support placed under the tail wheel spring at the fuselage attach point.

The main wheels can be raised by lifting one wing at a time at the wing struts next to the wing attach fittings. Place a suitable support under or just outboard of the U bolt on the upper gear leg.

CAUTION

Do not lift on the rear spar alone or near the jury struts. Avoid metal to metal contact on the gear leg and U bolt.

The aircraft may also be hoisted by a spreader bar type sling attached to the front spar attach fittings. The wing root fairing must be removed for access to the fittings.

MOORING

In the event of high winds, the aircraft should be properly secured.

- 1) Head aircraft into the wind if possible
- 2) Attach tie-down chains or ropes to the tail wheel assembly and tie down fittings at the end of the wing struts
- 3) Set parking brakes
- 4) Secure the control stick aft with the forward seat belt
- 5) Install control surface blocks for the rudder and flaps
- 6) Install pitot tube cover

INSPECTION AND SERVICING ACCESS

The Citabria is designed to keep maintenance and inspection time to a minimum.

The two piece engine cowl is easily removed for engine servicing. Remove the top half first. When removing the lower half, disconnect the light wire using the quick disconnect below the inspection door on the top cowl. The air induction hose connected to the air filter must also be disconnected. Replace the cowl in the reverse order. Do not tighten fasteners until the cowl is completely in place.

CAUTION

When installing lower cowl, insure that the air filter inlet hose is properly mated to the carburetor heat box. It is recommended that the air filter be removed for inspection of proper positioning of the air filter inlet hose.

The flexible engine baffle seals should be facing up and forward prior to replacing the top cowl for proper engine cooling.

Additional inspection plates are provided on the wings and fuselage to gain access to control cables, fuel lines, wiring, etc. The cabin headliner also permits easy access to the overhead control cables and fuel lines.

FUEL SYSTEM

Use 80/87 minimum octane or 100/130 (100/130 low lead for 7ECA) octane aviation fuel. Observe all required precautions when fueling the aircraft. Fill each wing tank through the respective filler neck on the top surface of the wings. The caps are non-vented type and must be properly secured or fuel will siphon out and feed unevenly during flight.

NOTE

Because of crossfeeding between the two tanks, they should be retopped during refueling to assure maximum capacity.

A quick drain is provided on the gascolator with access to the control knob through the inspection cover on the engine cowl. This should be used during the preflight inspection to check for fuel contamination.

The system low point drain is located externally on the fuselage belly aft of the rear seat and should be used during unusually high moisture conditions or if water is present in the gascolator.

Each tank also has a drain plug to remove fuel from the tank if necessary.

WARNING

After using drains, insure that no leakage is evident.

BATTERY

The battery is located behind the baggage compartment (7ECA, battery located in engine compartment) and sealed in a leak proof container. To gain access, remove the aft baggage compartment panel. The battery should be checked every 50 hours (10 hours for aerobatic flight) or 30 days for proper electrolyte level and evidence of spilled

Add only distilled water for maximum service life. Fill until the level is approximately 1/16" - 1/8" above the plates. If acid spillage or corrosion is present, neutralize with a solution of water and baking soda. Do not allow the solution to come in direct contact with the electrolyte in the battery cell.

If the battery is to be removed, disconnect the ground cable (negative) first and install last.

BRAKES

The brake fluid reservoir is mounted to the aft side of the firewall. A filling port is on top of the reservoir and the overflow vent is located at the upper right main gear leg.

The reservoir can also be replenished under pressure by using the brake bleed fittings on the bottom of the wheel brake assembly.

CAUTION

Use only MIL-H-5606 hydraulic fluid (red).

TIRES

Tire condition should be checked during preflight. If the tire tread is no longer visible, it should be replaced. Inflate tires with compressed air.

Main Wheels - 24 ± 2 psi
Tail Wheel - 40 ± 10 psi

ENGINE LUBRICATION

Access to the oil filler port and dip stick is through the inspection door on the engine cowl. The oil level should be checked prior to flight and oil added if below six quarts (5 quarts - 7ECA).

Under normal operating conditions, the oil should be changed every 25 hours of operation (50 hours if a full flow oil filter is installed). A quick drain is provided on the engine sump with access through the cooling duct below the engine cowl.

Use aviation grade oil with the proper viscosity as listed in Figure 7-1.

ENGINE AIR FILTER

The engine air filter should be inspected every 50 hours of normal operating or every 10 hours under extremely dusty conditions. Clean with compressed air or replace as necessary.

CLEANING

EXTERIOR SURFACE

Wash with mild soap and water. Avoid the use of harsh abrasives or detergents. Remove grease and oil with solvent or non-leaded gas. The aircraft may be waxed if desired with a good quality automotive wax.

Ice may be removed from the wings using a 50/50 solution of isopropyl alcohol and water. Do not allow solution to come in contact with the plexiglass windows.

WINDSHIELD

The windshield and side windows should be cleaned with an aircraft windshield cleaner following the manufacturer's recommendations. If dust or dirt is present, rinse with water prior to cleaning. The windshield can be waxed and polished with a soft cloth to fill minor scratches and help protect against further scratching.

CAUTION

Do not use gasoline, benzine, alcohol, octane, carbon tetrachloride, lacquer thinner or glass cleaner on the plexiglass as crazing will result. Never rub with a dry cloth as the surface can be easily scratched.

ENGINE

The engine can be washed down with a commercial engine solvent or kerosene base solvent. Avoid excessive contact of solvents on the electrical components such as the magnetos, starter, etc.

INTERIOR

The vinyl interior can be washed with mild soap and water. The carpet should be cleaned with any commercial or household upholstery or carpet cleanser approved for nylon type material.

STORAGE

Aircraft placed in non-operational storage for long periods of time should be given a thorough cleaning. Every ten days the propeller should be pulled through several revolutions to reactivate the oil film and prevent corrosion.

WARNING

Check that all engine switches and controls are OFF prior to rotating the propeller and stay clear of the propeller area.

To insure long engine life, the aircraft should be flown at least once a month to reduce excessive moisture buildup. Excessive ground running to bring engine to operating temperature is not recommended. Consult the engine manual for further recommendations if this is not possible.

The fuel tanks should be kept full to prevent moisture buildup due to condensation.

Insure that the battery is kept fully charged or the electrolyte will freeze and damage the battery in cold weather.

ABBREVIATED CHECK LIST

(A complete and more detailed checklist including the preflight inspection, can be found in Section III)

START

1. Seat Belt/ Shoulder Harness - FASTENED
2. Fuel Shut -Off Valve - ON
3. Electrical Switches - OFF
4. Master Switch - ON
5. Magneto Switches - ON (2)
6. Throttle - CRACKED OPEN (1/2" to 1")
7. Carb Heat - COLD
8. Mixture - FULL RICH
9. Prime - AS REQUIRED
10. Propeller - CLEAR, front & rear
11. Brakes - Check FIRM
12. Starter - ENGAGE
13. Throttle - 1000 to 1200 RPM
14. Oil Pressure - WITHIN 30 SECONDS
15. Engine Instruments - CHECK for Proper indication
16. Lights/ Radios - AS DESIRED

TAKE OFF

1. Controls - CHECK FREE
2. Trim - SET for Take Off
3. Fuel Valve - ON
4. Mixture - FULL RICH
5. Engine Run-Up - 1700 RPM (Elevator - FULL BACK)
 - a) Magnetos - CHECK (200 RPM maximum drop, 50 RPM max. differential)
 - b) Carb Heat - CHECK then return to Cold position.
 - c) Engine Instruments - CHECK normal indications.
 - d) Throttle - 1000 RPM
6. Cabin Doors/ Windows - CLOSED & LATCHED
7. Seat Belts/ Shoulder Harness - FASTENED
8. Lift Off - 55 - 60 MPH
9. Climb 75 - 80 MPH (Best Rate - 69 MPH)
10. Mixture - Full Rich below 5000 ft.

CRUISE

1. Throttle - Set as Desired
2. Mixture - Lean when Below 75 % Power

LANDING

1. Seat and Shoulder Harness - FASTENED
2. Mixture - FULL RICH
3. Brakes - CHECK FIRM (Park brake - OFF)
4. Approach Airspeed - 60 - 70 MPH

SHUT - DOWN

1. Mixture IDLE CUT-OFF
2. Electrical Switches - ALL OFF
3. Magnetos/ Master Switch - OFF after prop stops.
4. Controls - SECURE with lap belt around forward control stick only.
5. Wheels - CHOCKED
6. Wing/ Tail Tie Downs - SECURE

ABBREVIATED CHECK LIST

(A complete and more detailed checklist including the preflight inspection, can be found in Section III)

START

1. Seat Belt/Shoulder Harness

FASTENED

F Electrical Switches -OFF

u

e

l

S

h

u

t

-

O

f

V

a

l

v

e

-

O

N

3

.

4

.

5

.

Master Switch -ON

Magneto Switches -ON (2)